

Veterinary Instruments Catalogue



Manufacturers & Exporters of Veterinary Instruments

Health and feed are basic things for animal life like a human



Certificate of Registration



The Governing Board of
Q.A. International Certification Limited
hereby grants to:

AZQA INSTRUMENTS
Registration No. QAC / PC / 1712 - B

Hereafter called the Registered Company the right to be listed in the Directory of Registered Companies in respect of the services listed below. These services shall be offered by the Registered Company at or from only the address given below in accordance with the quality management system in compliance with the Requirements of **ISO 13485:2016**.

Address to which this Certificate refers:

Sadaye Shekar Road, SIE Sialkot 51310 Pakistan

Approved Scope to which this Certificate refers:

Manufacturers of Non-Active Surgical, Dental Instruments & Scissors.

(Please note that the above scope represents the certified activity of the named organization and as such, the organization may undertake additional activities that are not covered under this certification.)

Signed for and on behalf of the Board:

CHIEF EXECUTIVE

SCHEME MANAGER

Certificate Issue Date: 13th February 2019 - Certificate Renewal Before: 13th February 2020
Date of Initial Registration: 13th December 2017 - Re-Certification Before: 14th December 2020

This Certificate of Registration is granted subject to the Regulations approved by the Board.

QA INTERNATIONAL

QA International Certification Ltd.
Hafiz Road
Dera Ismail Khan
Punjab
Pakistan
Tel: +91 98700 88877
Fax: +91 98700 88878



DEPARTMENT OF HEALTH & HUMAN SERVICES

Public Health Service

APR 16 2019

Mr. Muhammad Rizq
Chief Executive
AZQA INSTRUMENTS
Sadaye Shekar Road,
SIE Sialkot
51310 Pakistan

and

Mr. Mohammed Ashraf
Quality Management Consultant
Near Hakkal Masjid
Nasir Road
Sialkot, Pakistan

Dear Messrs. Rizq and Ashraf:

This is to acknowledge receipt of a March 1, 2019, letter from Mr. Mohammed Ashraf certifying the compliance of **AZQA INSTRUMENTS Industries (AZQA)** with the Food and Drug Administration (FDA) Quality System Regulation of 1997, which includes the current good manufacturing practice (CGMP) requirements. The Quality System Regulation is set forth in Title 21, Code of Federal Regulations (CFR), Part 820. The consultant certification confirmed that a quality system audit of Hajmoy was performed February 28, 2019.

The quality system audit report states that manufactures responsible surgical instruments. Based on our review of the audit results and certification, **AZQA** has been placed in Attachment A of Import Alert #76-01. You may begin exporting devices to the United States (U.S.) that were manufactured after the consultant certified your firm's compliance with the CGMP; however, your shipments may be subject to the guidance outlined in Attachment A of Import Alert #76-01. After five consecutive shipments comply with the import alert guidance, you may request your firm be placed on Attachment B. Submit your request directly to the FDA district office for their concurrence and further submission to this office for action.

The placement of the firm on Attachment A is limited to devices manufactured under the name of **AZQA INSTRUMENTS Sadaye Shekar Road, SIE Sialkot 51310 Pakistan**.

In the event the manufacturing name and/or address change, FDA requests that notification be immediately forwarded to this office. A change in the name and/or address of the manufacturing facility without notifying FDA will result in a re-evaluation of the compliance status of your firm.

Food and Drug Administration
Center for Devices and
Radiological Health
2900 Gateway Road
Bethesda, MD 20892



Subsidiary Public Health

Mr. D Iqbal
Blue Star Company
48, Thornhill Road
Newport Green
Southall
Middlesex
UB8 3BQ

19 October 2018

Dear Mr. D Iqbal,

MEDICAL DEVICES REGULATION 2002: REGULATION 19
Registration of Persons Placing Medical Devices on the Market

Thank you for forwarding the Competent Authority of the details of Manufacturers (None) - for whom you are acting as the authorized representative and for supplying the medical device information.

Your registration has been recorded based on your declaration that you have determined that the device(s) fall within the definition of "medical device", and that you have classified it/them as falling within Regulation 19 taking into account the intended purpose(s) and mode(s) of action. In accepting your registration, I should make clear that the Competent Authority does not examine each individual notification and therefore cannot and does not necessarily endorse these determinations. Neither does this letter represent any form of accreditation or approval by the UK Competent Authority.

Your registration is based upon your declaration on the R12 form and states that:

For Manufacturers of Class I medical devices, Accessories, and Spare Parts:
You should now be operating under the Medical Devices Directive and the above Regulations for the products you asked us to register, to fully complying with the essential requirements, CE marking those products or labeling them as such.

For Manufacturers of Class II medical devices:
You should be ready to claim compliance with the Directive and Regulations and should be conducting systematic device in accordance with their requirements.

If you are placing devices on the market or if you are not complying with the Regulations you should inform us so that we can amend our records. You should be aware that it is an offence to place on the market CE marked devices that do not comply with the regulations.



An Executive Agency of the Department of Health

Certificate of Registration



The Governing Board of
Q.A. International Certification Limited
hereby grants to:

AZQA INSTRUMENTS
Registration No. QAC / PC / 1815 - A

Hereafter called the Registered Company the right to be listed in the Directory of Registered Companies in respect of the services listed below. These services shall be offered by the Registered Company at or from only the address given below in accordance with the quality management system in compliance with the Requirements of **ISO 9001:2015**.

Address to which this Certificate refers:

Sadaye Shekar Road, SIE Sialkot 51310 Pakistan

Approved Scope to which this Certificate refers:

Manufacturers of Surgical, Dental, Veterinary, Beauty Care Instruments & Scissors.

(Please note that the above scope represents the certified activity of the named organization and as such, the organization may undertake additional activities that are not covered under this certification.)

Signed for and on behalf of the Board:

CHIEF EXECUTIVE

SCHEME MANAGER

Certificate Issue Date: 28th February 2019 - Certificate Renewal Before: 13th February 2020
Date of Initial Registration: 13th February 2019 - Re-Certification Before: 13th February 2022

This Certificate of Registration is granted subject to the Regulations approved by the Board.

QA INTERNATIONAL

QA International Certification Ltd.
Hafiz Road
Dera Ismail Khan
Punjab
Pakistan
Tel: +91 98700 88877
Fax: +91 98700 88878



Page 2 - Messrs. Rizq and Ashraf

The FDA is assured by both the consultant and **AZQA** that no devices will be imported into the U.S. that are not specifically manufactured by **AZQA**. This includes other manufacturers in Pakistan completing specific manufacturing processes for **AZQA**, and other manufacturers in Pakistan providing their devices to **AZQA** for importation into the U.S.

The decision based on your consultant certification will remain in effect until such time as FDA is able to visit Sialkot, Pakistan for an inspection of your facility. During this inspection all corrections and procedures will be evaluated and confirmed. Any new CGMP deviations, or any uncorrected deviations that were previously certified to, may result in a re-evaluation of the compliance status of your firm, **AZQA**, including the possibility of removal from Attachment A.

We request that a quality system follow up audit be performed at **AZQA**, within six months of exporting devices to the U.S. We will be advised of the timing of FDA's inspection schedule.

AZQA has an ongoing responsibility to conduct internal self-audits to assure you continue to maintain conformance with the Quality System Regulation.

If you have any questions regarding this correspondence, or need further assistance, please contact me at (301) 594-4595 or FAX (301) 594-6636.

Sincerely yours,

Carol Z. Shirk
Consumer Safety Officer
General Surgery Devices Branch
Division of Enforcement I
Office of Compliance
Center for Devices and
Radiological Health

The information you provided has been covered against the reference number shown at the top of this letter, which we ask you to quote in all future correspondence and communications.

Please inform us of any changes to:

- The company information.
- Additional generic group of devices (eg individual products within an existing generic group).
- Discontinuation of a generic group of devices.

Please use REG1, the Registration Form, to tell us about any of these changes.

Thank you for registering the following generic groups of devices:

Class I Devices:
Dental Instruments (Re-Usable & Non-Powered)
Surgical Instruments (Re-Usable And Non-Powered)

Custom Made Devices:
None

Products Covered By Article 12:
None

Should you have any queries regarding your registration please contact us on the telephone number given at the top of this letter.

Yours sincerely

Roh Higgins



CA014167



ACCREDITED COMPANY
BS EN ISO 9001:2008
BS EN ISO 13485:2003
QAIC/PC/3587-A
QAIC/PC/3589-B



300957719



GMP Approved Facility



A-20939



S286



1256696-9

All third party names/logos/trademarks are the property of their respected owners.



Ai-001
White's Modified Emasculator with extra crushing area. Stainless steel. 12".



Ai-002
White's Modified Emasculator. Stainless steel. 8". (not pictured)

Ai-003
Even Crush Emasculator. Extra crushing area moves as crushing takes place. Stainless steel. 12"



Ai-007
Small Emasculator.
Stainless steel. 7 1/2"



Ai-004
Sand's Castrator. Crushing only.
Stainless steel.



Ai-008
Reimer Emasculator.
Ai-009
Reimer Emasculator.

This very popular emasculator has a double crushing part. The cutting lever is worked separately. This allows extra time for crushing action and diminishes afterbleeding. stainless steel. 12 1/2"

Ai-010
Hauptner Reimer Emasculator. Chrome.



Ai-005
Hausman Standard Emasculator.
Stainless steel. 12"



Ai-011
Bloodless Castrator
23cm
(for Lambs and Rabbit)



Ai-006
Frank's Emasculator.
Stainless steel. 7 1/2"



Ai-012
Castrator Heavy Duty with Pin size 9"

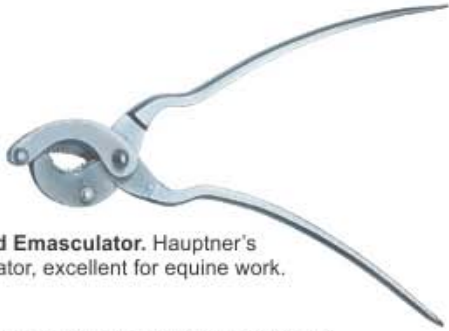

Ai-013
Serra Modified Emasculator. Hauptner's finest emasculator, excellent for equine work. Chrome. 14".

Ai-014
Serra Modified Emasculator. Stainless steel. 14"



Ai-015
Serra Emasculator. Ratchet holds emasculator lock, as in J-37. Chrome. 14".

Ai-016
Serra Emasculator. Stainless steel.



Ai-017
Newberry Castrating Knife. Stainless steel. 10 1/2"L. (Blade is non-replaceable.)



Ai-018
JorVet Emasculatome. With cord stop for bloodless castration. Includes wrench on all models.
 Emasculatome. 9"
 Emasculatome. 12"
 Emasculatome. 14"
 Emasculatome. 16"
 Emasculatome. 19"



Ai-019
Knee Brace for large models.



Ai-020
Ecrasseur. This is the popular ratchet type ecrasseur by Chassaignac. Stainless steel. German-made. 19".



Ai-021
Reimer Emasculator s/s M09. 12 1/2"L. European made.



Ai-022
Serrated, Curved Spay Scissors. 12".
Serrated, Curved Spay Scissors. 16" for flank approach in spaying heifers.



Ai-023
Castration Kit. Scalpel handle together with 6 sterile scalpel blades. On a display card
 # 22 blades with large red nylon handle
 # 12 blades with large red nylon handle



Ai-024
Frank Emasculator
Stainless German 9"



Ai-034
Castrating knife Set Metal handle covered with solid wooden pieces, contains five knives.



Ai-025 Burdizzo Castrator, Baby 9"
Ai-026 Burdizzo Castrator, Small 12"
Ai-027 Burdizzo Castrator, Medium 13"
Ai-028 Burdizzo Castrator, Large 15"
Ai-029 Burdizzo Castrator, Indian 19"



Ai-030
Plain Emasculator,
Stainless German 12"



Ai-035
Reimer Emasculator
For Crushing Only



Ai-031
Twitches; 30" Long; Rope twitch



Ai-036
Hetzel Emasculator



Ai-032
Twitches; 30" Long; Stainless chain twists in both directions



Ai-033
Castrating knife spay/Hoe, 3"



Ai-037
Emasculator in
Plastic Body



Ai-038
Marking Ring Applicator Stainless Steel

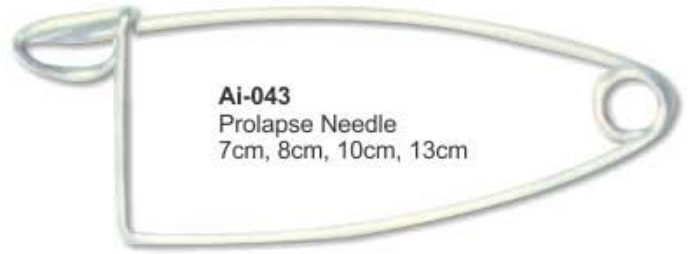

Ai-043
Prolapse Needle
7cm, 8cm, 10cm, 13cm



Ai-039
Marking Ring Applicator



Ai-044
Bull Nose
Ring Applicator



Ai-040
Heavy Duty Marking Ring Applicator



Ai-045
Bull Nose Ring
Applicator With
Vertical Opening Delivered
With A Break-off Screw



Ai-041
Bull Holder
Size 15"



Ai-046
Bull Nose Ring Applicator With
Vertical Opening Delivered
With A Break-off Screw
Size 13"



Ai-042
Bull Holder with chain
Size 12"



Ai-047
Bull Nose Ring Applicator
For Bull Rings Size 12"



Ai-048
With Pig Staples Applicator
Made of Aluminium With
Adjustment Screw Size 6"



Ai-053
Bull Holder with spring
Size 7cm, 11cm



Ai-049
Bull Holder Harm's With
Rowel Slide Size 18 cm



Ai-054
Automatic Lock Easily Released
Bull Lead, Aluminum Size 3"



Ai-050
Bull Holder With Push
Button Lock Size 18 cm



Ai-055
Automatic Lock Easily Released
Bull Lead Brass Size 4"



Ai-051
Bull Holder With Spring
Size 7 cm, 11 cm



Ai-056
Bull Leader to Catch the Ring
and to Facilitate the Animal
Manipulation Size 4"

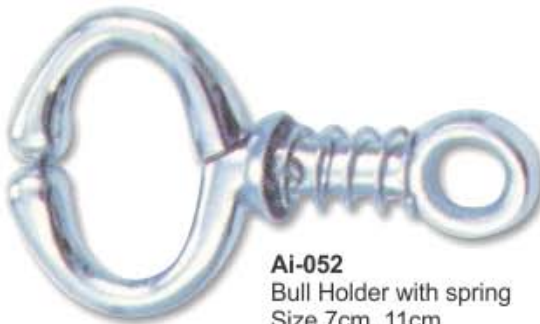

Ai-052
Bull Holder with spring
Size 7cm, 11cm



Ai-057
Bull Holder Continental
Tong Pattern, Size 43cm



Ai-058
Bull Holder with spring
Size 7 cm, 11 cm



Ai-062
Heavy Duty Bull
Holder without chain
Size 20cm 22cm



Ai-059
Bull Holder with Side Gripe
Size 20cm 22cm



Ai-063
Bull Holder Harm's With
Slide Adjuster made of S.S
Size 18 cm



Ai-060
Heavy Duty Bull
Holder with chain
Size 20cm 22cm



Ai-064
Milk Sucking Preventor Plier
Available In Red Colour Also
Size 18"



Ai-065
Pig Nose Ring Applicator
Size 10"



Ai-061
Heavy Duty Bull
Holder with chain
Size 20cm 22cm



Ai-066
Bull Ring Halter
Size.....



Ai-067
Bull Ring
Stainless Steel
Sizes are 55mm
and 65mm



Ai-072
Bull Ring Stainless Steel
60mm, 70mm, 80mm,
90mm, 100mm

Ai-068
Bull Ring
Stainless Steel
Sizes are 55mm
and 65mm



Ai-069
Bull Ring Copper
60mm, 70mm, 80mm,
90mm, 100mm



Ai-073
Bull Ring Nickel Plated
60mm, 70mm, 80mm,
90mm, 100mm



Ai-070
Bull Ring Stainless Steel
60mm, 70mm, 80mm,
90mm, 100mm



Ai-071
Bull Ring Brass
60mm, 70mm, 80mm,
90mm, 100mm

Ai-074
Bull Ring Brass
60mm, 70mm, 80mm,
90mm, 100mm



AI-075
Hoof Forceps



AI-081
Shoe Puller to Grab Hold
of The Shoe Removal
Size 14"



AI-076
Hoof Clamp
Black Coated



AI-082
Diamond Shoe Puller & Spreader Round
Knobs on of Handles Size 15"



AI-077
Round Hoof Tester
Size 13"



AI-083
Black Steel Crocodile Plier With
Plastic Coated end (clincher)
Size 30cm



AI-078
Hoof Tester Round Large
Size 18"



AI-084
Black Steel Crocodile
Plier (clincher) Size 30cm



AI-079
Shoe Puller
Size 12"



AI-085
Diamond Nail Puller
Size 30cm



AI-080
Diamond Farrier Nippers
Size 14"



AI-086
Nail Nipper
Size 30cm



AI-087
Professional Hoof Nipper With
Wide Opening Size 30cm



Ai-088
Diamond Farrier
Clincher Size 30cm



Ai-093
Hoof Crease nail puller 12" (30cm)
stainless. for the removal of nails
especially when worn down inside
the grooves of the shoe.



Ai-089
Foot Rotshear with lock pin
Size 9"



Ai-094
shoe puller-spreader. 12" (30cm) stainless.
to remove the shoes or also to adjust a
shoe by spreading it of a better fit.



Ai-090
Foot Rot Shear
Size 9"



Ai-095
Hoof nipper or trimmer (13 1/2") 34cm stainless for
gentle trimming of the hoof.



Ai-096
clinch cutter. 6" double ended tool for opening the clinches
to reduce hoof wall damage during shoe removal. Beveled
on inside edge for closer cutting. Stainless. Other end is



Ai-091
Sheep Hoof Cutter
Size 9"

AZQA
INSTRUMENTS



Ai-092
Claw Cutter
Size 17"



Ai-097
Steel Hoof Trimmer. Popular compound action steel
model, with extra sharp blades that are replaceable.
Green with black handle grips. Suggested for use with
cattle. Size 40cm, 50cm



Ai-098
Hauptner Hoof Tester.
14 1/2".



Ai-099
JorVet Standard Hoof Tester.
stainless steel. 13".



Ai-100
Adjustable Hoof Tester. This sturdy model hoof tester has jaws of stainless steel and seven adjustments for every size hoof.



Ai-101
large Hoof Tester.
Heavy-duty. Stainless Steel. 13".



Ai-102
Extra Large Hoof Tester. 21". Max jaw opening is 20cm (8") which is much larger than standard tester. jaw teeth are large cleats for better hold. Stainless.



Ai-103
Ryding Hoof Tester. New design allows for adjustable jaws over entire hoof surface. The jaws remain parallel for more even and steadier diagnostic pressure. the handle accommodates one-handed use, leaving the other hand free to hold the leg or for positioning the hoof. stainless steel. patented.



Ai-104
Hauptner Hoof Knife. For the veterinarian who wants the very best. Small curl, ebony handle right or left curve. Blade 3/8" W x 2 1/2"L.

Ai-105 Hoof Knife. Left hand.

Ai-106 Hoof Knife. Right hand.



Ai-107
Right Curve Hoof Knife with brown wooden handle. Blade 5/8" W x 2 3/4"L.

Ai-108
Left Curve Hoof Knife with brown wooden handle. Blade 5/8" W x 2 3/4"L.



Ai-109
Swiss Hoof Knife. Length 7"

Ai-110
Folding Hoof Knife combined with hoof pick. Handy pocket size. Length 3"



Ai-111
Hoof Pick. Length 7"



Ai-112
Hoof Buffer.

Ai-113
Hauptner Hoof Knife Hone. Especially developed for hoof knives and will sharpen inside of curl.



Ai-114
Economy Hoof Knife Set.





Ai-115
Hoof Knife, Curved Blade,
Polished Wooden Grip



Ai-116
Hoof Knife, Extra Long Shaft,
Polished Wooden Grip



Ai-117
Hoof Knife, Narrow Blade,
Fine Wooden Grip

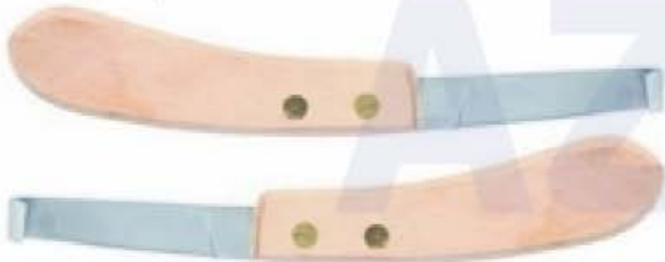

Ai-118
Hoof Knife, Wide Blade,
Fine Wooden Grip



Ai-119
Hoof Knife, Double Edged,
Length 7.5", Stainless Steel,
Polished Wooden Grip



Ai-120
Hoof Knife, Double Edged,
Small Size 6.5", Stainless Steel,
Polished Wooden Grip



Ai-121
Hoof Knife with small curl, double edge.
Blade 5/8"W x 2 3/4"L. Size 7"



Ai-122
Hoof Knife High quality Swiss-made instrument
with small curl, right or left curve.
Blade 5/8"W x 2 1/2"L. Size 7"

Ai-123 Hoof Knife Left hand.
Ai-124 Hoof Knife Right hand.



Ai-125 Hoof Knife Same as only featuring narrow 3/4"
blade, right or left curved. 2 1/2"L. Size 7"

Ai-126 Hoof Knife Left hand.
Ai-127 Hoof Knife Right hand.



Ai-128
Oval Hoof Knife



Hoof Searcher. Blade 2 1/2"L.



Ai-130
Foot-Rot Hoof Shear. Heavy handles
as illustrated, with strong spring and
safety clip. Specially designed tempered
steel serrated blades. Stainless steel.



Ai-131
Hugh's Angled Hoof Groover. This hoof groover
has an elliptical doughnut-shaped working end.
Elliptical opening is 2cm x 1cm. The bottom portion
is sharpened. It is great for digging out or curing
hoof abscesses. Stainless steel handles. 6 1/4"
(16cm) L.



Ai-132
Hugh's Straight Cutting Head Hoof Groover.



Ai-133
Small Loop Hoof Abscess Knife. Designed to curette out the smallest of abscess with this very sharp, but small loop. Ergonomic shaped wood handle.



Ai-134
Special Hoof Knife, Left
Size 8"



Ai-135
Special Hoof Knife, Right
Size 8"



Ai-136
Rasp without Handle
Size 12"



Ai-137
Rasp Barness Dehorners
with Wooden Handle
Size 12"



Ai-138
Rasp Barness Dehorners with
Metallic Handle and also
available in wooden handle
Size 12"



Ai-139
Rasp Barness Dehorners with
Metallic Handle and also
available in wooden handle
Size 17"



Ai-140
Oval Hoof Knife,
Available in wooden handle,
can be used left or right handed



Ai-141
Oval Hoof Knife,
Available in wooden handle,
can be used left or right handed.
Extra long shaft makes it easier
and more accurate to use



Ai-142
Hoof Parer
Size 14"



Ai-143
Hoof Rasp, Size 14"
long 3/4" wide



Ai-144
Mane Comb
P.U. 12
Small toothed, aluminium mane comb with hoof pick.



Ai-149
Thinning Scissors
with curved blades,
heavy model, S.S.



Ai-145
Mane Thinning Knife
brown
Folding stripping comb.



Ai-150
Trimming Scissors
With curved blade
and plasticized
grip, S.S.



Ai-146
Pocket-Knife
Multi-purpose stable
knife, with 5 parts,
S.S.



Ai-151
Hoof Pick
assorted - P.U. 25
Metal with moulded
plastic handle.



Ai-147
Thinning Scissors
with curved blades,
small model, S.S.



Ai-148
Mane Thinning Scissors
S.S. & plasticized grip



Ai-152
Clipper Both Sided Thin
& Wide Teeth Size 8"
Silver



Ai-156
Hand sheep clipper
Size 8" Silver



Ai-153
Hand sheep clipper
with wooden handle
Size 8"



Ai-157
Aluminium Mane Comb
with Wooden Handle
Size 8" Silver



Ai-158
Aluminium Jockey
Mane Comb
Size 4"



Ai-154
Hand sheep clipper
Size 8"



Ai-159
Aluminium Mane Comb
Size 8" Silver



Ai-155
Hand sheep clipper
with wooden handle
Size 8" Silver



Ai-160
Aluminium Mane Comb
Size 4"



Ai-161
Mini Hog Catcher
Rubber Grips
Size 18"



Ai-162
Pig Holder S.S
60cm, 180cm
200cm, 100cm



Ai-163
Pig Holder S.S
60cm, 180cm
200cm, 100cm



Ai-164
Hog Catcher with
Rubber Grips
60cm, 180cm
200cm, 100cm



Ai-165
Pig Catcher
60cm, 180cm
200cm, 100cm



Ai-166
Calving Forceps, S.S
Size 24"



Ai-167
Balling Gun with Plastic Head
with or without spring
Size 18"



Ai-168
Calf Puller
Size 72"



Ai-169
Calving Assist Forceps S.S
Size 22"



Ai-170
Obstetric Forceps For Pig About
52cm Long, S.S Size 20"

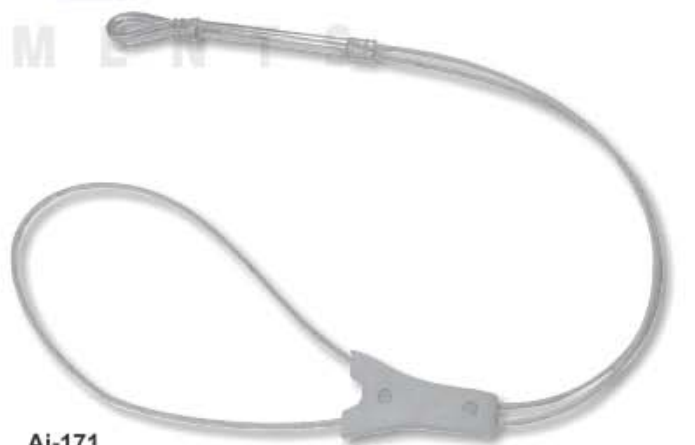

Ai-171
Calf Head Snare
Size 26", 40"



Ai-172
Obstetrical Chain
Size 26cm, 53cm, 75cm
150cm, 190cm



Ai-173
Pig Catcher S.S
Size 18"



Ai-174
Pig Catcher
with Plastic Handle
Size 18"



Ai-175
Aluminum Mini
Hog Catcher
Size 20"



Ai-176
Pig Catcher
Size 18"



Ai-177
Professional Toe Nail Nipper 16cm
Compound Action,
Stainless Steel (Satin finish)



Ai-183
Professional Toe
Nail Nipper
Size 14cm



Ai-178
Professional Toe Nail Nipper 16cm
Compound Action, Stainless Steel
(Satin finish)



Ai-184
Professional Toe
Nail Nipper
Size 14cm

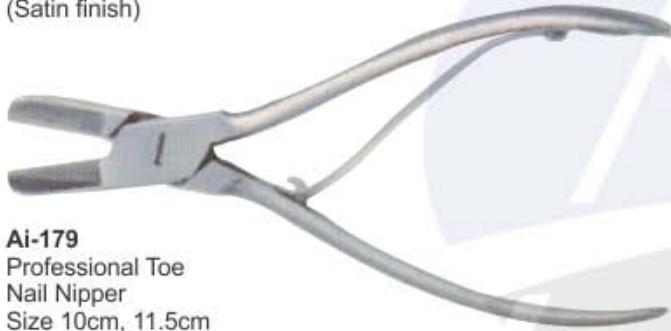

Ai-179
Professional Toe
Nail Nipper
Size 10cm, 11.5cm



Ai-185
Nail Profiler (with grip)
14.5cm
Stainless Steel
(Powder coated)



Ai-180
Professional Toe
Nail Nipper
Size 10cm, 11.5cm



Ai-186
Nail Profiler (with grip)
14.5cm
Stainless Steel (Powder coated)



Ai-181
Toe Nail Nipper 14cm
Box Joint, Double Spring
Stainless Steel (Satin finish)



Ai-187
Nail Profiler 14.5cm
Stainless Steel



Ai-182
Professional Toe Nail
Nipper 16cm Double Action,
Stainless Steel (Satin finish)

Ai-188
White's Toenail scissors. 4".



Ai-189
White's Toenail scissors.
German-made. 4".



Ai-190
Cat Claw Scissors
Stainless steel. 3" (7.5c)



Ai-191
Bird Nail Trimmer.



Ai-192
JorVet Guillotine Style Nail Trimmer.
Size 5".



Ai-193
Two-Sided Nail File.
Size 6".



Ai-194
Heavy-Duty Nail Scissors.
Size 6 1/2".



Ai-195
Small Heavy-Duty Nail Trimmer.
Size 5"



Ai-196
New Style Nail Trimmer.
Size 6 1/2"



Ai-197
New Style Nail Trimmer.
Size 5 1/2" Lighter and
smaller version.



Ai-198
OB Caesarean Forceps.
 Stainless steel. Size 12"

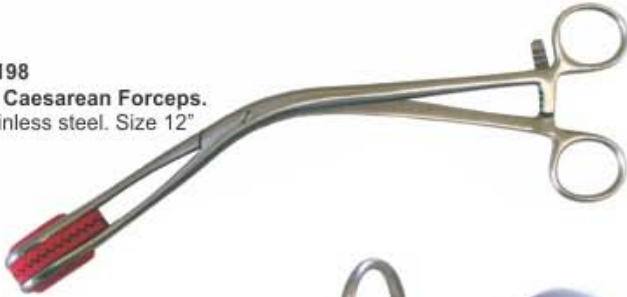

Ai-199
Linde's Embryotomy Knife
 Stainless steel. Size 5"



Ai-200
Guenther's Embryotomy Knife
 Stainless steel. Size 2 1/2"



Ai-201
OB Saw Wire.
 10 meters.



Ai-202
Hauptner OB Wire.
 10 meters.



Ai-203
Thygesen's Fetatome.
 Size 33"
 10 meters.



Ai-204
Insertion Coil and Cleaning Brush
 for fetatomes.



Ai-205
Utrecht Fetatome
 Lightweight model
 Size. 38"



Ai-206
Moore Obstetric Chain 30", S.S or N.P
 Size 26cm, 53cm, 75cm, 150cm, 190cm



Ai-207
Obstetric Chain 60", S.S or N.P
 Size 26cm, 53cm, 75cm, 150cm, 190cm

Ai-208
Krey Hook
 Stainless steel. Size. 8"



Ai-213
Hauptner OB Wire Guide
 Size. 7".

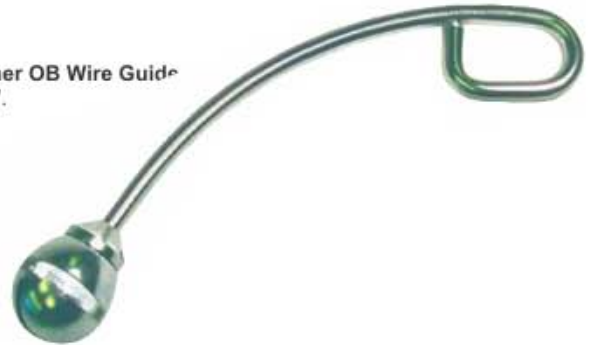

Ai-209
Ostertag's Blunt Eye Hook.
 Stainless steel. Hole 5/8" dia.
 Hook 3/4". Total 2".



Ai-210
Ruggeberg's Spring-Type
OB Double-Eye Hook.
 Very easy to use. 5 1/2".

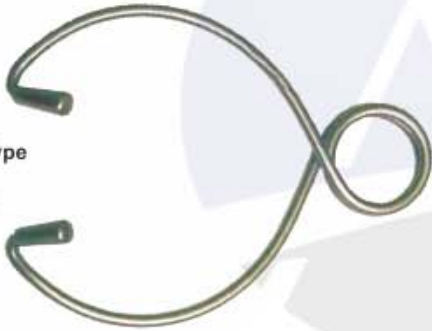

Ai-214
OB Wire Drop Guide.
 Stainless steel. Size. 3 1/2".



Ai-211
Vienna Double Blunt Eye Hook.
 Stainless steel.
 Hinged for easier placement. 5 1/2"

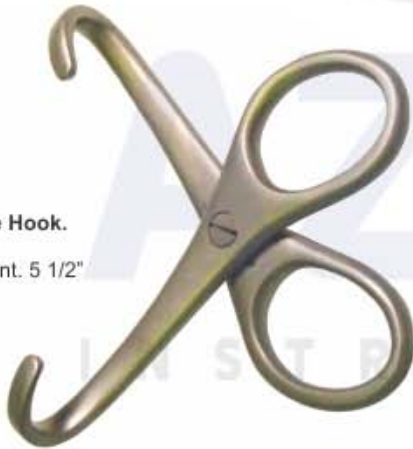

Ai-215
Swedish OB Wire handle
and wire Container.



Ai-216
OB Wire Handle
 Size 3 1/2"



Ai-212
OB Wire Guide.
 Size. 7".



Ai-217
Sutter Style OB Handle.
 Knurled non-slip grip. 4".





Ai-218
Pig Obstetrical Forceps.
Size. 23"

Ai-222
OB Chain Handle.
Stainless steel.



Ai-223
T-Bar OB Handle.
Size. 22cm.



Ai-219
McLean Whelping Forceps.
for small breeds. Size. 8"



Ai-220
Lyss OB Handle.
Stainless steel.
sold individually.
Size 3".



Ai-221
JorVet Calving Strap.
Size. 1"



Ai-224
Moore's OB Chain Handle.
Stainless steel.



Ai-225
Chain Handle.
Stainless steel with plastic
laminated handles for easier grip.



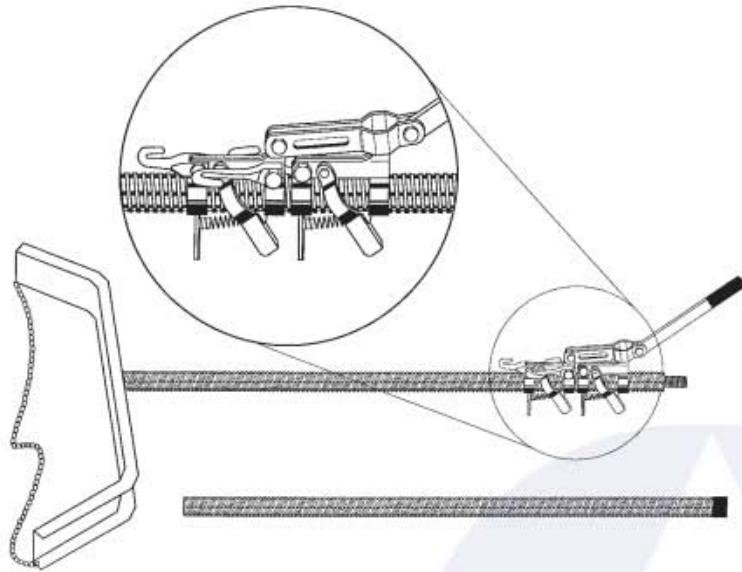

Ai-226
Hercules Fetal Extractor.



Ai-227
Tattooing Forceps
(B)



Ai-228
Tattooing Forceps
©, (D) Size 13"



Ai-229
Tattooing Forceps
(E)

Ai-230
Size 8"

Individual Replacement Parts are Available. OB Chains Sold Separately.



Ai-231
Wire Handle
Size 4"

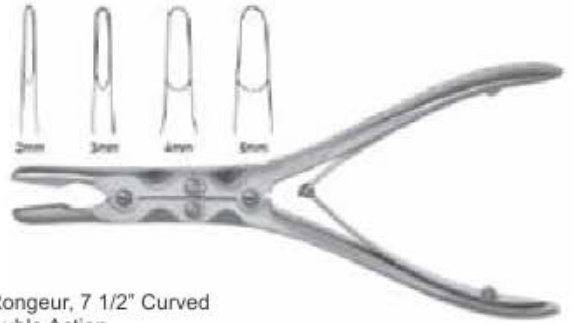

Ai-236
Ruskin Rongeur, 7 1/2" Curved
5mm, Double Action



Ai-232
Wire Handle
Size 4"



Ai-237
Dental Extracting Forceps,
Upper Bicuspids,
Incisors and Roots, 286



Ai-233
Tag Applicator Plier
Size 7"



Ai-238
Dental Extracting Forceps,
Upper Anteriors, Plit Beaks,
Serrated, 150A



Ai-234
Ear Notcher - A-type
Size 10"



Ai-239
Dental Extracting Forceps,
Lower Incisors, Cuspids, and
Bicuspids and Roots,
Universal, 151



Ai-235
Dean (Blumenthal) Rongeur, 6"
3 x 10mm bite tapered to 4mm,
slightly curved jaw



Ai-240
Dental Extracting Forceps,
Upper and Lower Fragments
and Roots, 69



Ai-241
Dental Extracting Forceps,
Mead, Md4, Lower 1st,
2nd and 3rd Molars,
Universal



Ai-242
Dental Extracting Forceps,
Lower Roots, 74
English Pattern



Ai-243
Reynolds cap extractor,
Upper, 15" Long



Ai-244
Reynolds Cap Extractor
Lower, 15 1/2" Serrated



Ai-245
Reynolds Cap Extractor
Lower, 19" Long Serrated



Ai-246
Upper/Lower Separating Forceps for spreading or
seperating incisors or wolf teeth before extraction, 10" Long



Ai-247
Cow Horned Forceps
For extracting short or broken
incisors, 10 1/2" Long



Ai-248
Fragment Forceps For Removing
tooth splinters and roots,
10 1/2" Long



Ai-249
Three Prong Forceps For Extracting
reminates of pre-molars, 11" Long



Ai-250
Set of 4 Upper/lower Separating Forceps, Cow Horned Forceps,
Fragment Forceps, and Three Prong Forceps



Ai-251
Three Prong Root Forceps,
Left, 19"



Molar Forceps, Concave,
Long Jaw Box Joint, 19"



Ai-252
Three Prong Root Forceps,
Right, 19"



Ai-257
Spreader, 18 1/2",
Bulb Handle, Stainless Steel



Ai-253
Four Prong Root Forceps,
19"



Ai-258
Molar Spreader, 20",
Stainless Steel



Ai-254
Four Prong Root Pony Forceps,
12"



Ai-259
Fulcrum Serrated, SS Forceps,
19"



Ai-255
Incisor Forcep, Bulb Handle,
19"



Ai-260
Hewson's Tooth Forceps,
14"



Ai-261
Fragment Forceps, Long Needle
19"



Ai-267
Wolf Tooth Forceps
7" Long,
Stainless Steel



Ai-262
Incisor Forceps
14"



Ai-268
Wolf Tooth Forceps
7" Long,
Stainless Steel



Ai-263
Molar Root Fragment Forceps
19"



Ai-269
Fragment Forceps
8" Long,
Stainless Steel



Ai-264
Molar Forceps, 14" Long,
Right Angle



Ai-270
Wolf Tooth Forceps
7 1/2" Long,
Stainless Steel



Ai-265
Molar Forceps, 12" Long,
Right Angle



Ai-271
Wolf Tooth Forceps
9 1/2" Long,
Box Jointed



Ai-266
Wolf Tooth Forceps
7 1/2" Long,
Stainless Steel



AI-272
Tooth Cutter



AI-273
Tooth Cutter



AI-274
Wolf Tooth Forceps



AI-275
Wolf Tooth Forceps



AI-276
Guenther's forceps
15cm (Tooth extracting forceps)
Parallel shape



AI-277
Guenther's forceps
Oval shape



AI-278
Wire Cutter



AI-279
Equine Molar Cutter. Powerful compound action. Breakdown model for easy storage. stainless steel. 11 1/2" handle. 25"L.

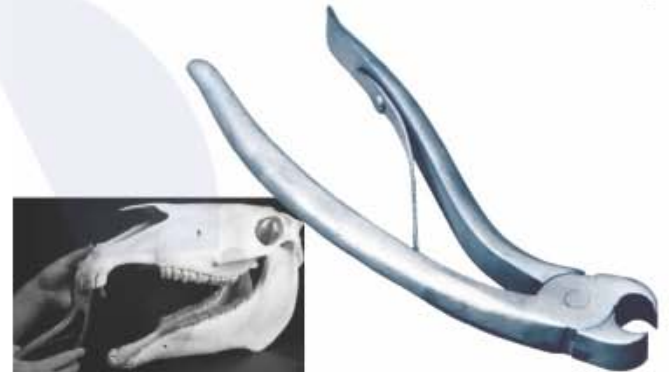

AI-280
Deciduous Incisor Tooth Forceps. Spring handle increases holding power. Stainless steel. 20cm L.



AI-281
Dental Tooth Punch. The Punch is used for removal of cheek teeth through a trephined hold into the sinus.
Tooth Punch. Straight.
Tooth Punch. Curved.



AI-282
Dental Chisel with sliding bar or percussion handle. The working end has a notched "V". It work great for removing upper premolar hooks and lower rear molar hooks. stainless steel. 23"L. collapsed.

Ai-283
Recherdson
Size: M, L



Ai-284
Meet Hanging
Hook



Ai-285
Tongue
Depressor



Ai-286
Dental Picks



Ai-287
Dental Mirror



Ai-288
Dehorner



Ai-289
Calf Milk Whisk



Ai-290
20" Shaft, includes blade.



Ai-291
26" Shaft, includes blade.



Ai-292
Curved float blade with tungsten
carbide chips, fits universal float.



Ai-293
Standard Dental Float with both straight
and angled shaft with one
interchangeable handle. 20"L.



Ai-294
House Float Angle Shaft only.
Ai-295
House Float Straight Shaft only.



Ai-296
House Float Interchangeable handle only.

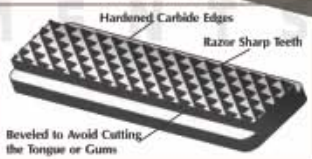

Ai-297
Float Blade. Medium grit.
Ai-298
Float Blade. Coarse grit.



Ai-299
Flat Float Blade with tungsten carbide
chips fits any standard float. 1" x 3 1/4".

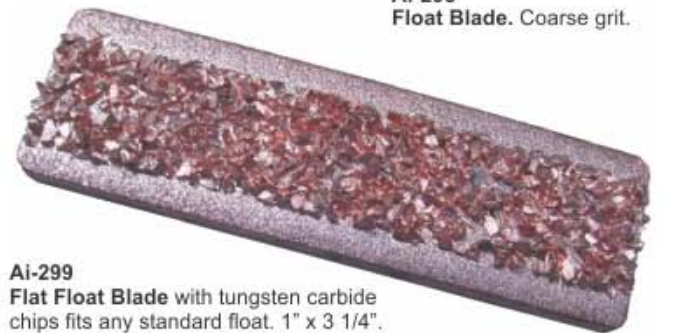



Ai-300
Rear Molar Float. Specially designed for dropping over and onto the last molar and removal of hook that can develop on the caudal edge of that tooth. 13 1/2" L shaft.



Ai-301
Premolar Float. with short right angle shaft. Especially effective on premolar hooks and special "bit" requirement.



Ai-302
Angle or Obtuse Float. For use on upper arcade molars. 11 1/2" shaft.



Ai-303
Offset Molar Float. Excellent for rear molars. 13 1/2" shaft.



Ai-304
Straight Molar Float. 13 1/2" shaft.



Ai-305
Proctor Float makes it easy to float the first two premolars. Tungsten carbide chips. 12" L.



Ai-306
"S"-Shaped Hand Rasp. This is especially useful as a finishing tool on the upper premolars. Tungsten carbide 30cm L.



Ai-307
Pistol Grip Handle, only. 42cm.



Ai-308
Burgess Wolftooth Set.



Ai-309
Wolftooth Elevator.



Ai-310
Wolftooth elevator set.



Ai-311
Deluxe Wolf Tooth Elevator with ergonomic handle. 22cm L.

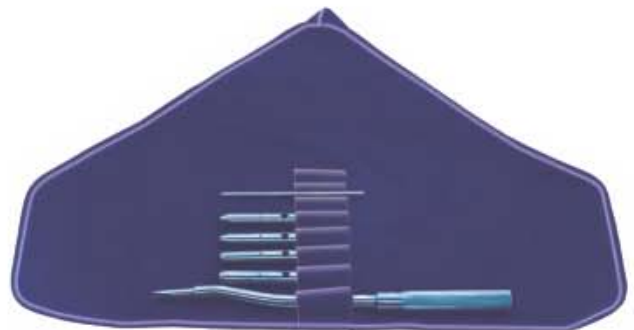

Ai-312
Deluxe Wolf Tooth Elevator Set.

Ai-313
EquiVet Cheek Spreader



Ai-3134
EquiVet Dental Mirror.
"T" shaped handle. 19" length.



Ai-315
EquiVet Dental Pick.
"T" handle. Stainless steel. (48cm) 19"



Ai-316
EquiVet Perpendicular Gingival Elevator.
"T" handle. (48cm) 19"



Ai-317
EquiVet Parallel Gingival Elevator.



Ai-318
Set of all Three Gingival
Elevators And Picks



Ai-319
Dental Pick
Ai-320
Perpendicular Gingival
Elevator
Ai-321
Parallel Gingival
Elevator



Ai-322
Compound Ronguer.
Large 6mm bite
slightly curved head.
9" Length.



Ai-323
Full Mouth Speculum; Includes 2
Mouth plates & Biothane Halter

Ai-324
Full Mouth Speculum; Includes 2
Mouth plates & Leather Halter

Ai-325
Mouth Plates;
Set of 2 SS Mouth Plates



Ai-326
Gum Bars



Ai-327
Rubber Mouth Wedge;
3 1/2" Long,
1 1/2"- 1 7/8" Wedge



Ai-328
Miniature Pony Size Wedge;
3 1/4" Long,
1 1/4"- 1 5/16" Wedge



Ai-329
Rubber Mouth Wedge
Replacement Piece

Ai-330
Miniature Rubber
Replacement Piece



Ai-331
Rubber Mouth Wedge
Stainless steel Plate
Ai-332
Miniature Rubber Mouth Wedge
Stainless Steel Plate



Ai-340
Rectangular Dental Fulcrums,
2 fulcrums, 5/16", 3/8",
7/16", 1/2"



Ai-333
Heavy Dental Pick 15 1/2" Length,
5/8" Width, 1/2" Tip Depth



Ai-341
Gracey Curette, 18" Long



Ai-334
Heavy Dental Straight Pick 16"
Length, 5/8" Width, 1/2" Tip
Depth



Ai-342
Periodontal Probe, 15 1/2" Long,
3mm, 6mm, 9mm, 12mm, 15mm,
18mm, and 21mm Markings



Ai-335
Dental Punch, 8mm Tip, 8" Long,
3/4" Diameter Handle

Ai-336
Dental Punch, 12mm Tip, 8" Long,
3/4" Diameter Handle



Ai-337
Dental Punch Set of Four, 12.5mm
offset, 20mm offset, 20mm Curved,
20mm Straight

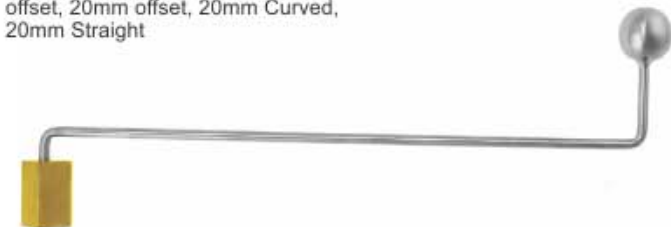

Ai-338
Dental Fulcrum, 3 different height
aluminum heads

Ai-339
Dental Fulcrum, 4 different height
aluminum heads



Ai-343
Original Burgess Set,
Two Tips: S, M., Cordura Case,
Non-Slip Steel handle,
Straight & offset extensions, Pick



Ai-348
Sims Uterine Curettes,
Sharp Malleable Shaft, 11", Size 00



Ai-349
Sims Uterine Curettes,
Sharp Malleable Shaft, 11", Size 0



Ai-350
Sims Uterine Curettes,
Sharp Malleable Shaft, 11", Size 1



Ai-351
Sims Uterine Curettes,
Sharp Malleable Shaft, 11", Size 2



Ai-344
Improved Burgess Set, Choice of
three tips: XS, S, M, or L, Improved
sculpted handle, Straight & offset
extensions, Cordura case, pick



Ai-352
Sims Uterine Curettes,
Sharp Malleable Shaft, 11", Size 3



Ai-345
Dental Probe Pointed Tip,
17 1/2" Long

Ai-353
Sims Uterine Curettes,
Sharp Malleable Shaft, 11", Size 4



Ai-346
Dental Explorer

Ai-354
Sims Uterine Curettes,
Sharp Malleable Shaft, 11", Size 5



Ai-347
Cheek Retractor



Ai-355
Sims Uterine Curettes,
Sharp Malleable Shaft, 11", Size 6





Ai-356
Wolf Tooth Elevator, 4mm Stainless Steel Tip, 6" Length, Hollow Handle

Ai-357
Wolf Tooth Elevator, 4mm Tip, 6" Length, Hollow Handle



Ai-358
Wolf Tooth Blade, 9mm Tip, 6" Length

Ai-359
Wolf Tooth Blade, 9mm Tip, 6" Length, 5 or More

Ai-360
Wolf Tooth Elevator, 9mm Tip, Sharp, 6 3/4" Length

Ai-361
Wolf Tooth Elevator, 9mm Tip, Sharp 6 3/4" Length, 3 or More



Ai-362
Wolf Tooth Handle Only



Ai-363
Gingival Elevators, Right



Ai-364
Gingival Elevators, Left



Ai-365
Elevators, 90 Degree angle down, 14"



Ai-366
Elevators, 90 Degree angle up, 14"



Ai-367
Elevators, 90 Degree angle left, 14"



Ai-368
Elevators, 90 Degree angle right, 14"



Ai-369 Winged Elevator, #4, Short Handle
Ai-370 Winged Elevator, #5, Short Handle
Ai-371 Winged Elevator, #6, Short Handle
Ai-372 Winged Elevator, #7, Short Handle
Ai-373 Winged Elevator, #8, Short Handle



Ai-374
Solid Bulb Handle Elevator, 4mm Stainless Steel Tip
Wolf Tooth Elevator, Length 4 3/4"
Ai-375
Solid Bulb Handle Elevator, 4mm Stainless Steel Tip
Wolf Tooth Elevator, Length 5 7/8"

Ai-376
Solid Bulb Handle Elevator, 5mm Tip, Stainless Steel, 4 3/4"
Ai-377
Solid Bulb Handle Elevator, 8mm Blunt Tip, Stainless Steel
Solid Handles, 6" Length



- Ai-378**
Winged Elevator Short Handle
1.2mm Backward Angle
- Ai-379**
Winged Elevator Short Handle
2mm Backward Angle
- Ai-380**
Winged Elevator Short Handle
3mm Backward Angle
- Ai-381**
Winged Elevator Short Handle
4mm Backward Angle

- Ai-382**
Winged Elevator Short Handle
5mm Backward Angle
- Ai-383**
Winged Elevator Short Handle
6mm Backward Angle
- Ai-384**
Winged Elevator Short Handle
7mm Backward Angle
- Ai-385**
Winged Elevator Short Handle
8mm Backward Angle

- Ai-386**
Winged Elevator Long Handle
1.2mm Backward Angle
- Ai-387**
Winged Elevator Long Handle
2mm Backward Angle
- Ai-388**
Winged Elevator Long Handle
3mm Backward Angle
- Ai-389**
Winged Elevator Long Handle
4mm Backward Angle

- Ai-390**
Winged Elevator Long Handle
5mm Backward Angle
- Ai-391**
Winged Elevator Long Handle
6mm Backward Angle
- Ai-392**
Winged Elevator Long Handle
7mm Backward Angle
- Ai-393**
Winged Elevator Long Handle
8mm Backward Angle



- Ai-394**
Winged Elevator Short Handle
1.2mm Forward Angle
- Ai-395**
Winged Elevator Short Handle
2mm Forward Angle
- Ai-396**
Winged Elevator Short Handle
3mm Forward Angle
- Ai-397**
Winged Elevator Short Handle
4mm Forward Angle

- Ai-398**
Winged Elevator Short Handle
5mm Forward Angle
- Ai-399**
Winged Elevator Short Handle
6mm Forward Angle
- Ai-400**
Winged Elevator Short Handle
7mm Forward Angle
- Ai-401**
Winged Elevator Short Handle
8mm Forward Angle

- Ai-402**
Winged Elevator Long Handle
1.2mm Forward Angle
- Ai-403**
Winged Elevator Long Handle
2mm Forward Angle
- Ai-404**
Winged Elevator Long Handle
3mm Forward Angle
- Ai-405**
Winged Elevator Long Handle
4mm Forward Angle

- Ai-406**
Winged Elevator Long Handle
5mm Forward Angle
- Ai-407**
Winged Elevator Long Handle
6mm Forward Angle
- Ai-408**
Winged Elevator Long Handle
7mm Forward Angle
- Ai-409**
Winged Elevator Long Handle
8mm Forward Angle

I N S T R U M E N T S



- Ai-410**
Luxation Elevator, Straight Tip
2mm, 5 3/4"
- Ai-411**
Luxation Elevator, Curved Tip
2mm, 5 3/4"

- Ai-412**
Luxation Elevator, Straight Tip
3mm, 5 3/4"
- Ai-413**
Luxation Elevator, Curved Tip
3mm, 5 3/4"

- Ai-414**
Luxation Elevator, Straight Tip
4mm, 5 3/4"
- Ai-415**
Luxation Elevator, Curved Tip
4mm, 5 3/4"

- Ai-416**
Luxation Elevator, Straight Tip
5mm, 5 3/4"
- Ai-417**
Luxation Elevator, Curved Tip
5mm, 5 3/4"



Ai-418
Offset Elevators
Angle Up, 16°



Ai-419
Offset Elevators
Angle Down, 16°



Ai-420
Offset Elevators
Angle Right, 16°



Ai-421
Offset Elevators
Angle Left, 16°



Ai-422
Offset Elevators
Set of Four, Up,
down, right, and
left angle, 16°



Ai-423
Elevators, Periosteal,
Molt, Del M9



Ai-424
U.S. Army Pattern Osteotomes,
6 1/2", 6mm

Ai-425
U.S. Army Pattern Osteotomes,
6 1/2", 12mm

Ai-426
U.S. Army Pattern Osteotomes,
6 1/2", 18mm

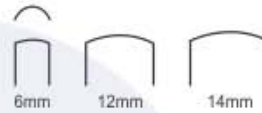

Equine Dental Gouge



Ai-427
Army Pattern Gouge
6 1/2", 12mm

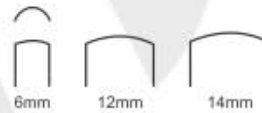

Ai-428
Army Pattern Gouge
6 1/2", 14mm



Ai-429
Army Pattern Gouge
6 1/2", 6mm



Ai-430
Army Pattern Gouge
6 1/2", 9mm, Curved

Ai-431
Milk Sucking Preventor
with Spring Made of
Aluminium & Having
2 Models with or
without Spikes
Size 4"



Ai-434
French Style Milk Sucking
Preventors Mini, Sml, Med, Lrg



Ai-432
Plastic Milk Sucking Preventor
With Different Colours With
Different Sizes



Ai-435
Spiked Swingarm Milk Sucking
Preventors Made of Metal With
Adjustment Nut
Size 4"



Ai-433
French Style Milk Sucking
Preventors Mini, Sml, Med, Lrg

Ai-436
French Style Milk Sucking
Preventors





AI-437
Stomach Pump
Size 12"



AI-438
Stomach Pump
Size 12"



AI-439
Balling Gun, Upto 6 Boluses
Can Be Administrated Per Animal,
Pistol Grip Handle

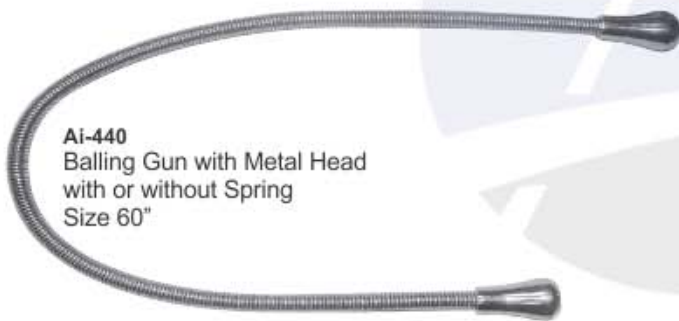

AI-440
Balling Gun with Metal Head
with or without Spring
Size 60"



AI-441
Balling Gun with Metal Head
with or without Spring
Size 18"



AI-442
Balling Gun with Rubber
Head with or without spring
Size 18"



AI-443
Balling Gun with Plastic
Head with or without spring
Size 18"



AI-444
Balling Gun with Metal
Head with or without spring
Size 18"



AI-445
Syringe



AI-446
Syringe



AI-447
Syringe with Plastic Handle



AI-448
Revolver Syringe, Heavy Duty
Syringes with Metallic Body &
Glass Barrel Available in
10ml, 30ml, 50ml



AI-449
Revolver Syringe, Heavy Duty
Syringes with Metallic Body &
Glass Barrel Available in
10ml, 30ml, 50ml



AI-450
Syringe



AI-451
Revolver Syringe
Cover Leather



Ai-452
Balling Gun With Spring Clip.
2 3/4" L, 1" dia. head.



Ai-453
Plastic Head With Spring Clip.
2 1/2" L, 7/8" dia. head.



Ai-454
Calf Balling Gun Clip.
1 1/2" L, 5/8" dia. head.



Ai-455
Adult Balling Gun.
Holds up to six full-size
bolises. 7/8" dia.



Ai-456
Balling Gun.
Calf. 5/8" dia head. Blue. 13 1/2" L.



Ai-457
Balling Gun.
Calf, with ribbed 5/8" dia head. White.



Ai-458
Balling Gun.
Cow. 7/8" dia head. Red. 17 1/2" L.



Ai-459
Kant Suk Calf Weaner.



Ai-460
Lamb Nipple.
Red. 4/pk.



Ai-461
Hug's Teat Knife.
Blade 1/2". Stainless steel. 6"L.



Ai-462
Popular Danish Model Teat Knife,
with the short cutting and probe point. Stainless steel.



Ai-463
Christensen Teat Scissors,
with cutting edges on the outside of the blade;
adjustable opening. 6"L.



Ai-464
Cornell Teat Curette. Stainless steel. 6"L.



Ai-465
Lichy Teat Knife. Blunt. Stainless steel. 5 1/2" L.



Ai-466
Lichy Teat Knife. Sharp. Stainless steel. 5 1/2" L.



Ai-467
Round Trocar.
 Stainless steel with 10 plastic disposable cannulae. 5" shaft.



Ai-468
Oval Bloat Trocar with metal handle.



Ai-469
Round Metal Trocar
 with wood handle. 5" metal portion
 with 2 cannulas and one protective cap.

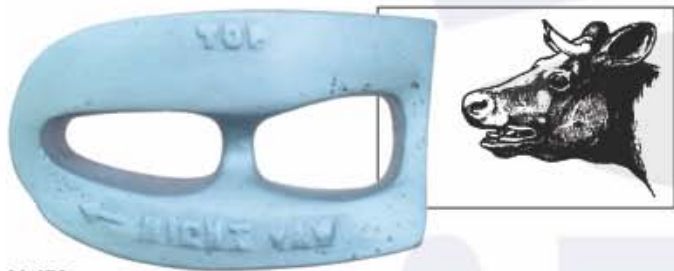

Ai-470
Drinkwater Mouth Gag
Ai-471
Mouth Gag. Right.
Ai-472
Mouth Gag. Left.



Ai-473
Frick's Standard Oral Speculum.
 Heavy-duty. Stainless steel. 19 1/2".



Ai-474
JorVet Bovine Hobble Strap.



Ai-475
Equine Humane Twitch.
 Stainless steel. 13"



Ai-476
Equine Chain Twitch.
 chain twitch with plated chain. 5" dia. loop
 with 25" flat wooden handle.



Ai-477
Polansky Vaginal Speculum.



Ai-478
Thoroughbred Vaginal Speculum.
 with 2 blades. stainless steel. 28cm (11").



Ai-479
Killian Vaginal Speculum.
 for dogs. has screw and 3 1/2"
 blades. Stainless Steel.



Ai-480
Anti Kick Clamp
Size 18"



Ai-484
Crook Head For Leg
Size 5"



Ai-481
Anti Kick Clamp
Size 18"



Ai-485
Sheep Cuff
Size 5"



Ai-482
Anti Kick Bar Spring
For Anti Kick Bar
Size 40"



Ai-483
Anti Kick Bar Spring
For Anti Kick Bar



Ai-486
shepherds Crook Neck Model
135cm



Ai-487
shepherds Crook Leg Model
95cm



plane (nylon)
convex (steel)
plastic handle
Head 30mm Ø
Weight 675 Gr.

1/5

MALLET
Ai-488
26 cm, 10 1/2"



plastic handle
Head 42 / 30mm Ø
Weight 530 Gr.

1/5

MALLET
Ai-489
26 cm, 10 1/4"



plastic handle
Head 30mm Ø
Weight 480 Gr.

1/5

MALLET
Ai-490
24 cm, 9 1/2"



Plastic Handle
Head 30mm Ø
Weight 510 Gr.

1/5

MALLET
Ai-491
26 cm, 10 1/4"



Spare Facing (pair)
Ai-493
Plastic

disks and plastic handle
Head 37mm Ø
Weight 370 Gr.

1/5

MALLET
Ai-492
22.5 cm, 9"



made of plastic
Head 30mm Ø
Weight 125 Gr.

1/5

MALLET
Ai-494
18 cm, 7"



made of plastic
with lead filling
Head 42mm Ø
Weight 400 Gr.
Head 42mm Ø
Weight 250 Gr.

1/5

MALLET
Ai-495
26 cm, 10 1/4"



made of plastic
with lead filling
Head 42mm Ø
Weight 250 Gr.

1/5

MALLET
Ai-496
26 cm, 10 1/4"



Ai-497
Parker's Tenotome Knife.
 Small, blunt and curved 15 x 3mm blade.



Ai-498
Tenotome Knife.
 Blunt and curved 5cm x 1/2cm blade.



Ai-499
Tenotome Knife.
 Blunt and straight 5cm x 1/2cm blade.



Ai-500
Tenotome Knife.
 Sharp and curved 5cm x 1/2cm blade.



Ai-501
Tenotome Splitter.
 Double edged blade.
 Stainless steel. 4cm L blade.



Ai-502
Chamber's Equine Catheter. Stainless steel with slightly curved tip. finger rest, luer slip adaptor. The preferred instrument for flushing the guttural pouch. also can be used for uterine flushes. 8g. 22"L.

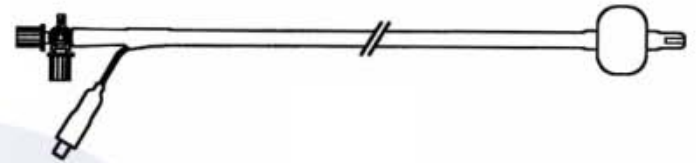

Ai-503
Broncho-Alveolar Lavage Catheter.

Equine Steinmann Pins



Ai-504
 Steinmann Pin Single Trocar 15mm Threaded, 9" 2.0mm, 5/64" pkg 6

Ai-505
 Steinmann Pin Single Trocar 15mm Threaded, 9" 2.4mm, 3/32" pkg 6

Ai-506
 Steinmann Pin Single Trocar 15mm Threaded, 9" 2.8mm, 7/64" pkg 6

Ai-507
 Steinmann Pin Single Trocar 15mm Threaded, 9" 2.0mm, 5/32" pkg 6

Ai-508
 Steinmann Pin Single Trocar 25mm Threaded, 9" 2.4mm, 3/32" pkg 6

Ai-509
 Steinmann Pin Single Trocar 25mm Threaded, 9" 2.8mm, 7/64" pkg 6



Ai-510
 Steinmann Pin Chuck Key,
 4" Cannulated Max, 5.0/7.0mm



Ai-511
G.P.G. Original
long cylinder - 12cm
short cylinder - 12cm



Ai-512
G.P.G. Original
long cylinder - 12cm
short cylinder - 12cm



Ai-513
G.P.G. Pro-grip Stirrups
12cm
with special grip sole.



Ai-514
G.P.G. Pro-grip Stirrups
Double Safety
12cm
These safety stirrups are
double asymmetrical,
have a special grip sole.
Used for eventing and
Icelander.



Ai-515
Stirrups
9.5cm
N.P., Closed
metal sole.

Ai-516
Stirrups
12cm
N.P., With
white sole.

Ai-517
Stirrups
10-11-12cm
N.P., Open
bottom.

Ai-518
Stirrups Filles
11-12cm
C.P., With
white sole.

Ai-519
Stirrups Filles
11-12cm
C.P., With
white sole.



Ai-521
Filles Stirrups
11-12cm
S.S. With black
sole.

Ai-522
Stirrups
Filles Flex
12cm
with hinged
foot, S.S.

Ai-523
Safety Stirrups
10-12cm
S.S. With rubber
ring, elastic
and open
bottom.

Ai-524
kwik Out
Safety Stirrups
11-12cm
S.S.

Ai-525
H.S. Safety
Stirrups
11-12-13cm
S.S. Flexible
foot part.

Ai-526
Safety Stirrups
12cm
S.S., Double
asymmetric
stirrup with
sole. Often
used for icelander

Ai-527
Metalab Stirrups
11-12cm
S.S., with swivelled-eye
and hinged foot.

Ai-520
Stirrups Filles
12cm
AGT, with
white sole.



Ai-528
Robert EggButt Snaffle
13.5cm
Dr. Bristol, double jointed, S.S.



Ai-533
Robert Ring Snaffle Bit
12.5 - 13.5cm
hollow, 2 extra rings, S.S.



Ai-529
EggButt Snaffle
12.5-13.5-14.5cm
AGT, Thick.



Ai-534
Nathe Ring Snaffle Bit
13.5cm
with 2 extra rings and flexible steel reinforcement.



Ai-530
EggButt Snaffle
13.5cm
Rubber, with flat rings, S.S.



Ai-535
Nathe Ring Snaffle Bit
13.5cm
with 3 extra rings and flexible steel reinforcement.



Ai-531
Happy Mouth EggButt Snaffle
11.5-12.5-13.5cm
pony size, with small S.S. Rings.



Ai-536
Happy Mouth Ring Snaffle
12.5-13.5-14.5 cm
Jointed mouth, with
3 extra S.S. rings.



Ai-532
Happy Mouth EggButt Snaffle
12.5-13.5cm
S.S. Rings.



Ai-537
Rubber Mouth Snaffle
13.5-14.5 cm
Flexible soft rubber black
mullen mouth, S.S. ring.



Ai-538
Robert Pelham
13,5 cm
Jointed rubber mouth, S.S.



Ai-542
Robert Bradoon
13-14-14,5 cm
Solid, ring snaffle,
S.S.

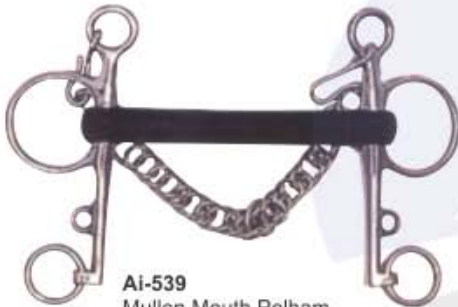

Ai-539
Mullen Mouth Pelham
13,5 cm
Slightly bent, soft rubber S.S.



Ai-543
Kk Schooling Bit
13 cm
Thick, solid eggbutt snaffle,
for the transition from snaffle
to weymouth, aurigan.



Ai-544
Robert Western Reining Bit
12,5 cm
Pinchless western training
bit, jointed mouth, S.S.



Ai-540
Robert Kimblewick Bit
14 cm
Jointed mouth S.S.



Ai-545
Robert Pro Reiner
12,5 cm
Pinchless western training
bit, S.S., Jointed mouth, S.S.
Ball and copper inlay.



Ai-541
K.K. Weymouth Bit
13.5cm
with double port mouth,
fixed cheeks, curb chain,
thick, solid, 18mm.,
Aurigan



Ai-546
Reining Horse Bit
12,5 cm
If your horse likes a snaffle,
but his mouth is feeling
numb, try this three piece
snaffle. It breaks over the
bars in a different place
creating a new feel. The
copper roller keeps the
mouth moist for a better feel.



Ai-547



Ai-548



Ai-549



Ai-550



Ai-551



Ai-552

Ai-547

Economic Country General Purpose Saddle
16" - 17" - 18" - havana, black
This saddle has a deep seat, leather knee pads and knee rolls.

Ai-548

Economic Junior General Purpose Saddle
15" - havana, black
This saddle has a deep seat, leather knee pads and knee rolls.

Ai-549

Economic Flexi Pony Saddle
15" - havana, black
This leather pony saddle with safety catches has no tree and fits almost on every pony. Ideal saddle for young riders.

Ai-550

Economic General Purpose Saddle
16" - havana, 18" - black
This saddle has soufflé pannels, knee rolls and leather kneepads.

Ai-551

Economic General Purpose Saddle
16" - 17" - 18" - black
This saddle has a deep seat, leather knee pads and adjustable knee rolls with Velcro.

Ai-552

Economic Pony Saddle
havana, black
This saddle is made of leather with felt. Supplied with girth and stirrup straps (stirrups not included). Perfect for young riders.



Ai-553
BR Jos Lansink Girth With Stud
125cm - 135cm - black, red, wood
With elastic on both ends and leather stud guard.
S.S. buckles



Ai-554
BR Classic Girth
105 up to 145cm - black
Leather padded girth and S.S. Buckles.



Ai-555
BR Leather Girth with Elastic
120 up to 145cm - Havana
110 up to 145cm - Black
Leather padded girth and S.S. Roller buckles.



Ai-556
BR Jos Lansink Girth
125cm - 135cm - black, red, wood
Pre-shaped girth with elastic on both ends with wide part in the middle. The girth has S.S. Buckles.



Ai-557
BR Jos Lansink Girth
125cm - 135cm - black, red, wood
Pre-shaped girth with elastic on both ends S.S. Buckles and a medicinally tanned sheepskin lining. During training you can replace the sheepskin lining for a neoprene lining. (Neoprene lining, art. 033 is not included)



Ai-558
BR Jos Lansink Girth With Stud Guard
125cm - 135cm - black, red, wood
With elastic on both ends, fixed leather stud guard, S.S. Buckles and a medicinally tanned sheepskin lining. During training you can replace the sheepskin lining for a neoprene lining (neoprene lining, art. 034 is not included).



Ai-559
BR Girth Lining
black
Neoprene, for the BR Jos Lansink girth art. 031.
Easily to attach with Velcro fastenings.



Ai-560
BR Girth Lining
black
Neoprene, for the BR Jos Lansink girth art. 032.
Easily to attach with Velcro fastenings.



Ai-561
BR Stud Guard
f/s - black
Leather stud guard, luxury, can easily be fastened to the girth, for jumpers.



Ai-562
BR Classic Stud Guard
f/s - havana, black
Leather lined with rubber, can easily be fastened to the girth, for jumpers.

Ai-563
BR Noseband
f/s - black
white lined dressage noseband,
English model with easy
tightening system and S.S. Buckles.

Ai-564
BR Noseband
f/s - x/f/s - black
extra wide, lined flash noseband
with easy tightening system and
S.S. Buckles.

Ai-565
BR Noseband
f/s - black
Lined flash noseband with easy
tightening system and comfortable
jaw protector, S.S. Buckles.

Ai-566
Flash Noseband
f/s - Premiere, S.S. Buckles, havana,
black, lined
f/s - Economic, S.N. Buckles, black

Ai-567
BR Grackle Noseband
f/s - havana, black
With S.S. Buckles, the nose
part is lined with sheepskin

Ai-568
BR Grackle Noseband
f/s - black
white brass rings and buckles, the
nose part is lined with sheepskin.

Ai-569
BR Noseband
f/s - black
Raised square flash noseband with
brass buckles. For bridle.

Ai-570
BR Noseband
f/s - black
Raised square flash noseband with
S.S. buckles. For bridle.

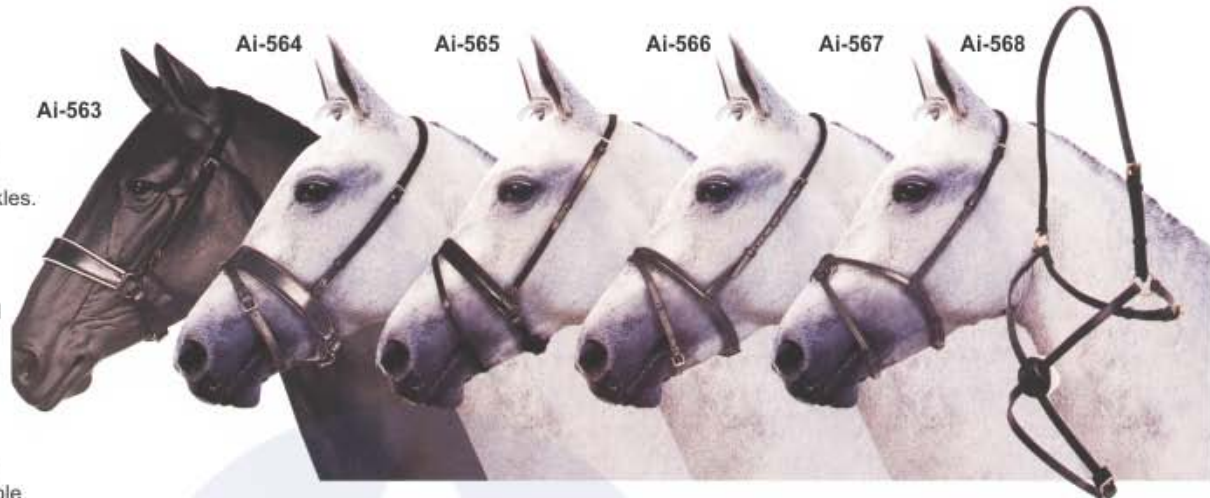

Ai-571
Premiere Noseband
f/s - p/s - c/s - black
wide flash noseband with easy
tightening system, raised and lined,
S.S. Buckles.

Ai-572
BR Dressage Noseband
f/s - black
wide soft lined noseband with
soft padded easy tightening
system, English model and with
a comfortable jaw protector.

Ai-573
BR Noseband
f/s - black
Rope cavesson noseband for
better interaction

Ai-574
BR Noseband
f/s - black
the cheek of this noseband gives
a better interaction if the horse
opens his mouth

Ai-575
Economic Noseband
f/s - black
Drop noseband.

Ai-576
BR Grackle Noseband
f/s - black
anatomically shaped nose part with
sheepskin lining.

Ai-577
Flash Noseband Attachment
f/s - havana, black
Buckles on to cabesson noseband, S.S.
Buckles.

Ai-578
Equitex Jaw Protector
black
Bultex, 10mm.

Ai-579
Jaw Protector
black
with alfa gel.

Noseband Cover
Ai-580- christ - natural - 28cm
Ai-581- chatelaine - acrylic fur
white , black, 27cm
Ai-582- chatelaine sheep's wool
natural - 28cm





AI-583

AI-583
BR Western Bridle
272000 - f/s - blue, red, black
splendid, simple nylon bridle with s.s
buckles. The bridle will be delivered
with matching reins and a bit.



AI-584

AI-584
Tuffy Western Bridle
272500 - f/s - brown, black
5/8" double stitched premium soft
nylon with 1/2" phoenix overlay.
The bridle will be delivered with
reins and bit. Made in USA. Match
to article 279503.



AI-585

AI-585
big horn western bridle
272501 - f/s - show brown, golden tan
Double bridle with brass buckles.
5/8" wide. Made in USA.



AI-586

AI-586
big horn western bridle
272502 - f/s - medium oil
this bridle with a knotted browband is
one of the most popular headstalls.
Made of 5/8" single ply-stitched harness
leather, hand finished with solid brass
buckles. Made in USA.



AI-587

AI-587
big horn ear bridle
272503 - f/s - show brown, golden tan
single ply-stitched slip ear headstall.
Made in USA.



AI-588

AI-588
big horn western show bridle
272504 - f/s - golden tan
Splendid western show bridle, luxurious
model. Knotted browband, mounted
with silver plated trim and enhanced
with jewellers bronze bars. The straps
are hand-rubbered, double stitched with
stained edges. Made in USA. Can be
ordered with matching reins, art. 279508



AI-589

AI-589
Big Horn Side Pull Bridle
272505 - f/s - medium oil
Heavy 5/8" single-ply, handlace harness
leather headstall with latigo curb strap
hand tied nylon lariat rope noseband.
The second ring for reins allows the
nose band to roll across a horse's nose
giving better head position. Ideal for
training. Made in USA.



AI-590

AI-590
Royal western ear headstall
272002 - f/s - black
with coloured ornaments
and leather reins.



AI-591

AI-591
Royal western headstall
272001 - f/s - havana, black
western weymouth headstall
in rolled leather, with reins.

Ai-592
Fleck Dressage Whip
120 cm. black
lacquered fibreglass, with luxury
bam-boo grip ad a nickel button.

Ai-594
Dressage Whip
95 cm.- black
lacquered fibreglass, with
a horse head button.

Ai-598
Dressage Whip
100 - 110 - 120cm - blue, red, black
Fibreglass, nylon thread stem, synthetic
button.

Ai-599
Ascot Dressage Whip
100 - 110 - 120cm - grey
nylon stem, black grip, silver-coloured
button

Ai-593
Dressage Whip
100 cm.- black
lacquered fibreglass, with
a horse head button.

Ai-595
Snowbee Jumping Bat
52cm - black, green, blue, black,
pink, blue, black, yellow, red.
PVC stem, leather "hand" shaped keeper.

Ai-596
Jumping Bat
65cm - green, blue, black, red.
Rubber non skid grip and leather keeper.

Ai-597
Fleck Jumping Bat
65cm - black
Fibreglass, nylon thread stem,
ruber grip, leather keeper.

Ai-598

Ai-599
Ai-600

Ai-601

Ai-600
Dressage Whip
100 - 110 - 120cm - black, black-white
Fibreglass, nylon thread stem, synthetic
grip.

Ai-601
Dressage Whip
100 - 110 - 120cm - black
Fibreglass, lacquered, white leather grip,
silver colored button.



Ai-602
Snowbee Riding Whip
75-90cm - Black, Black-White
Fibreglass, nylon thread stem, synthetic grip and wrist loop.

Ai-603
Riding Whip
75cm - Brown, Black, Black-White
Fibreglass, nylon thread stem with PVC grip and wrist loop.

Ai-604
Riding Whip
65cm - Blue, Brown, Green, Red, Black, Purple.
nylon thread stem, Fancy nylon wrist loop and keeper.

Ai-605
Riding Whip
56cm - Blue, Light-blue, Pink-black
Fiberglass, Nylon thread stem with synthetic grip & leather hand shaped, & keeper.

Ai-606
Riding Whip
70cm - Brown, Black
Pleated leather covered Nylon stem, leather wrist loop & keeper.

Ai-607
Fleck Riding Whip
80cm - Black
Fiberglass, Nylon thread stem, synthetic wrist loop & PVC button.

Ai-602

Ai-603

Ai-604

Ai-606

Ai-605

Ai-607



Deerskin

The BR riding gloves are made of deerskin. The hides are extra thick, elastic and supple. These gloves fit perfectly and comfortably. The gloves can be hand washed in lukewarm water with a soft detergent.

Ai-611



Ai-612



Ai-609



Ai-610



Ai-617



Ai-608



Ai-614



Ai-620



Ai-613



Ai-615



Ai-616



Ai-621



Ai-618



Ai-619



Ai-608

BR Riding Gloves
6 up to 10 - black
Luxury riding glove made of deerskin, without lining. In luxurious packing.

Ai-612

BR Riding Gloves
XS-S-M-L-XL - black
Traditional pigskin riding glove with demi-crochet back, lined with wool.

Ai-616

Riding Glove
XXS-XS-S-M-L-XL - brown
Riding glove made of neat's leather with crochet polyester/cotton back.

Ai-620

Riding Glove
XS-S-M-L-XL - black
Glove made of neat's leather with spandex back with velcro wrist fastening.

Ai-609

BR Riding Gloves
6 up to 9 - black
Exclusive, warm riding glove made of deerskin, with a cotton lining and finger reinforcements.

Ai-613

BR Riding Gloves
XS-S-M-L-XL - brown
Traditional pigskin riding glove with demi-crochet back, without lining.

Ai-617

Royal Riding Glove
XS-S-M-L-XL - brown
Strong glove made of neat's leather with suede back and velcro wrist fastening.

Ai-621

Driving Glove
S-M-L-XL-XXL - black
Unlined, neat's leather driving glove with velcro wrist fastening.

Ai-610

BR Riding Gloves
6.5 up to 10 - white
Luxury show riding glove made of deerskin, with a velcro fastening wrist strap, without lining.

Ai-614

BR Driving Gloves
7 up to 12 - natural
Made from Canadian deerskin, unlined, with finger reinforcements and velcro wrist fastening at the wrist.

Ai-618

Winter Riding Glove
7 up to 9.5 - brown
Warm winter riding glove made of pigskin, fleece lining and velcro wrist fastening.

Ai-611

BR Riding Gloves
7 up to 9.5 - natural
Made of deerskin, without lining.

Ai-615

Premiere Winter Riding Glove
XS-S-M-L-XL - black
warm winter glove made of neat's leather and lined with fleece, velcro wrist fastening.

Ai-619

Riding Glove
XS-S-M-L-XL - black
Riding glove made of soft and supple sheepskin, unlined with velcro wrist fastening.



Ai-622
Riding Glove
XS-S-M-L-XL - Blue, Brown,
Green, White, Black, grey,
Burgundy, Ochre.
Cotton glove with pimple palm,
finger reinforcements and velcro
wrist fastening.

Ai-623
BR Riding Glove all weather
XXS-XS-S-M-L-XL-XXL - Blue,
White, Black
riding glove made of PU. Coated micro
fiber and with a non-skid palm, these
are the most leather-like in feel gloves.
Supply to wear and easy maintenance.

Ai-624
BR Riding Glove Amara
XS-S-M-L-XL - Brown, White, Black
soft micro fiber glove, breathable,
washable 30°C.

Ai-625
BR Riding Glove Digital
XXS-XS-S-M-L-XL-XXL - White, Black
Made of PU. Coated micro fiber and
with a non-skid palm. These are the
most leather-like in feel gloves.
Supply to wear and easy maintenance.

Ai-626
BR Riding Glove
XS-S-M-L-XL - Black
a fine artificial leather glove with
fleece back and velcro wrist fastening.

Ai-627
Premiere Winter Riding Glove
XXS-XS-S-M-L-XL - Blue, Green,
strong, warm fleece glove,
reinforced with artificial leather.

Ai-628
Premiere Winter Riding Glove
Thinsulate
S-M-L-XL - Green,
very warm riding glove with velcro
fastening. This glove is wind & waterproof
and made of breathable material.

Ai-629
Winter Riding Glove
Blue, Green, black
strong, elastic winter glove.
One size, fits and hand.

Ai-630
Magic Glove (Adults)
Blue, Green, red, White, Black,
Burgundy, Purple, multi-colour
elastic glove with pimple palm
for extra grip. One size, fits and hand.

Ai-631
Magic Glove (Children)
Blue, red, White, Black,
Burgundy, Purple, multi-colour
elastic glove with pimple palm
for extra grip.
One size, fits and hand.



Instruments Tray with recessed handle on lid. Cold sterilization.
Ai-632 Top: 10 1/4" x 6 3/4" x 2". Bottom: 9" x 5 1/2" x 2".
Ai-633 Top: 12 1/4" x 8" x 2". Bottom: 10 1/2" x 6 1/4" x 2".



Instruments Tray with strap handle on lid.
Ai-634 Top: 10 1/4" x 6 3/4" x 2". Bottom: 9" x 5 1/2" x 2".
Ai-635 Top: 12" x 8 1/4" x 2 1/4". Bottom: 10 1/2" x 6 1/4" x 2".



Mayo Tray.
Ai-636 Top: 13 3/4" x 10" x 2/3". Bottom: 11 3/4" x 7 1/2" x 2/3".
Instruments on Spay Pack Tray. Below trays without lids.
Ai-637 Top: 10 1/4" x 6 3/4" x 2". Bottom: 9" x 5 1/2" x 2".
Ai-638 Top: 12" x 7 3/4" x 1 15/16". Bottom: 10 1/2" x 6 1/4" x 2".



Ai-639
Stainless Steel Bucket. 13-quart all-purpose bucket with handle. Type 304. 10 1/4"H. Base-7 7/8" dia., top-11 1/2" dia.



Ai-640
Round Straight-Sided Pail. 12-quart stainless steel with handle. This pail takes up less storage space than conventional pails.



Ai-641
Catheter and Instrument Tray with cover and strap handle. 3"W x 8 2/3"L x 1 1/2"H. (22cm x ~7cm x 3.8cm.)

Ai-642
Catheter and Instrument Tray with cover.
 Top: 3 1/2"W x 12 1/2"L x 1 3/4"H.
 (32.4cm x 9.3cm x 4.4cm).
 Bottom: 12" x 3" x 1 3/4".

Ai-643
Catheter Tray.
 Top: 16" x 3" x 2 1/2".
 Bottom: 15 3/4" x 2 3/4" x 2".



Ai-644
Dressing Jar. 1-liter capacity. 5"H (10cm x 15.9cm) x 5" dia.

Ai-645
Dressing Jar. 2-liter capacity. 6 1/4" (12.7cm x 15.9cm) x 5" dia.



Ai-646
Thermometer Jar. Stores glass thermometers. Wide base to give greater stability and avoid jar from tipping over. 3 1/4"H (3.4cm x 9cm) x 1 1/3" dia.



Ai-647
Collin Speculum
Sizes: S, M, L



Ai-651
Sims Speculum
with fixing screw and cut



Ai-648
Speculum for she-lamb



Ai-649
Greaves Speculum
Sizes: S, M, L



Ai-652
Sims Speculum
with fixing screw and cut



Ai-650
CUSCO Speculum
Sizes: S, M, L



Ai-653
Vienna Speculum
For small animals

Ai-654

Galt Skull Trephine, with adjustable centering point and detachable cross-bar handle, 13mm

Ai-655

Galt Skull Trephine, with adjustable centering point and detachable cross-bar handle, 19mm

Ai-656

Galt Skull Trephine, with adjustable centering point and detachable cross-bar handle, 25mm



Ai-657

2 Inch Trephine



Ai-658

Trephine Set with 3 attachments

Ai-659

Necropsy Knife, wide blade. 5"



Ai-660

Necropsy Knife, narrow blade. 5"



Ai-661

Curved Boning Knife. 6"



Ai-662

Necropsy Knife, Curved. 6"



Ai-663

Steel Sharpener.



Ai-664

Diamond Sharpener, Medium. Comes with leather case.



Ai-665

Postmortem Scissors. Heavy-duty scissors with one serrated edge and black finished rings. 2" cutting blade. 7 3/4"L.



Ai-666

Rib Shear. Cuts through rib case on small animals and younger large animals. German-made, stainless steel. 9" length.



Mouth Gags



Ai-667
Equine full Speculum including leather strap superior quality



Ai-670
Schulze Mouth Gags with wooden handle.



Ai-668
Mouth Plates



Ai-671
Schoupe Mouth Gags



Large



Medium



Small



Extra Small

Ai-669
Mouth Gags for Small Animals

Ai-672
Guenther's Mouth Gags
inside width 17.5cm
inside length 11cm.



Ai-673
Equestrian Equipments



Ai-674
Mouth Speculum
with leather straps



Ai-675
Mouth Speculum Haussmann
Model with Leather Straps,
or Nylon Straps



Ai-676
Lambing Aid Plastic
Small plastic snare with y configured head

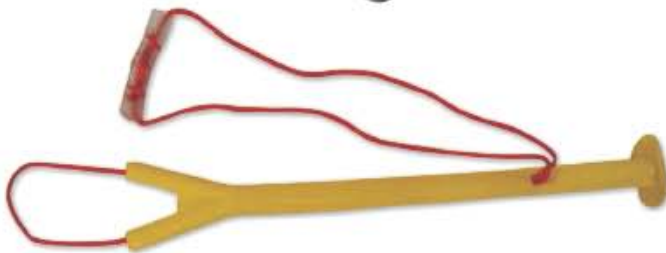

Marking Instruments

Ai-677
Tattoo Pliers
with revolving head,
for 3/8" four digits.

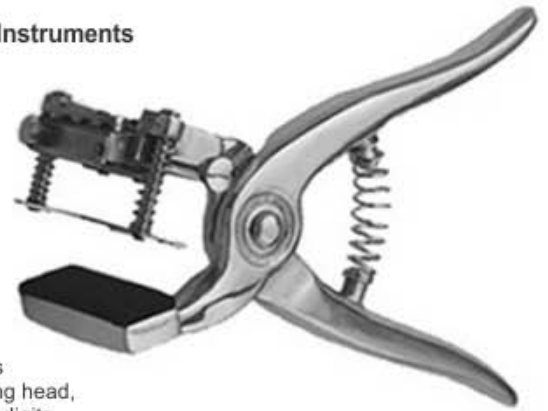

Ai-678
Tattoo Pliers
Standard,
for 3/8" four digits.



Ai-679
Tattoo Pliers



Ai-680
Tattoo Pliers Digits.
3/8" digits (0-9 & A-Z)



Ear Punch
Ai-681 - 3/8" Ear Punch
Ai-682 - 1/4" Ear Punch

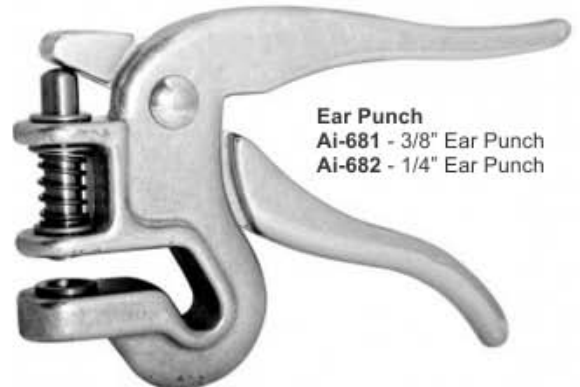

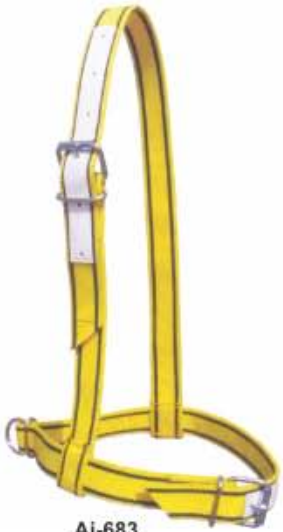

Ai-683
Cow Halter Nylon



Ai-684
Cow Halter Nylon
Adjustable on Headpiece
and noseband



Ai-685
Cow Halter Nylon
Adjustable on Headpiece
and noseband

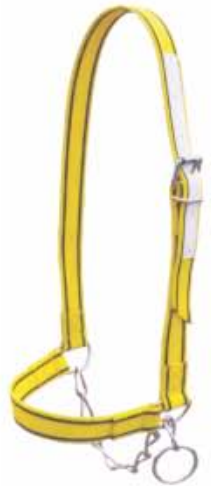

Ai-686
Cow Halter with chain,
Adjustable Headpiece

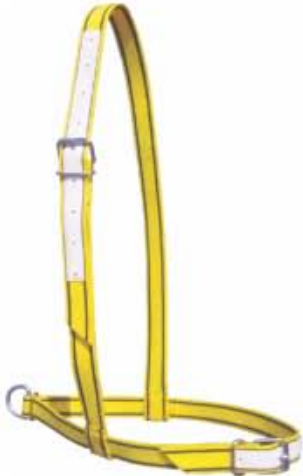

Ai-687
Bull Halter For Extra Big Bulls
Adjustable on Headpiece
and noseband



Ai-688
Cow Halter-Leather
Adjustable on Headpiece
and noseband



Ai-689
Sheep Halter Leather



Ai-690
Sheep Halter Leather



Ai-691
Calf Collar Nylon
Adjustable on Headpiece and noseband



Ai-692
Sheep Halter Leather



Ai-693
Sheep Halter Leather



Ai-694
Sheep Collar Nylon



Ai-695
Sheep Collar Nylon with swivel



Ai-696
Calf Collar Nylon
with swivel



Ai-697 Calf Collar Leather with swivel

Ai-698 Calf Collar Leather with swivel



Ai-699
Calf Collar Leather with Chain



Ai-700
Calf Collar 90cm
Nylon with Chain



Ai-701
Calf Collar 90cm
Nylon with Chain



Ai-702
Band Double
with Chain

Ai-703
Band Single
with Chain



Ai-704
Cattle Hobble Nylon
With Neoprene Foam Padding



Ai-705
Cattle Hobble made of
Soft Padded Webbing

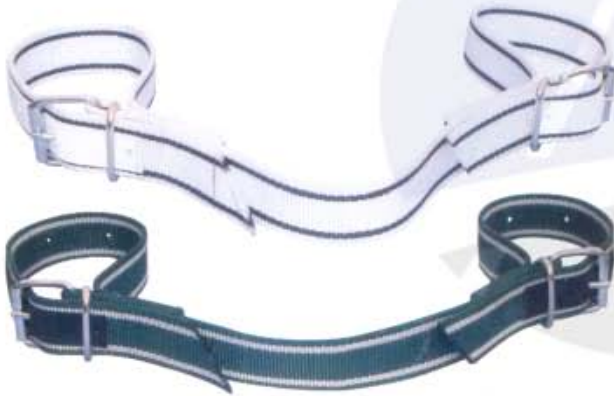

Ai-706
Cattle Hobble Nylon



Ai-707
Cattle Hobble-Leather



Ai-708
Cattle Hobble
Figure 8-Leather



Ai-709
Cattle Hobble Nylon Adjustable



Ai-710
Sheep Bell
with Nylon Belt



Ai-711
Cow Bell
American Style



Ai-712
Cow Bell
German Style



Ai-713
Cow Bell



Ai-715
Tool Belt Leather



Ai-716
Tool Belt Leather

Ai-717 Snake Tong
17" (182.5cm) constructed of blue top quality aluminum



Ai-718 Standard Snake Tong
52" Standard Snake Tong



Ai-719 Snake Tong
24"



Ai-720 Professional Reptile Snake Tong
25" Stainless Steel Wire.



Ai-721 Reptile Snake Tong
52" from handle to jaw
Stainless Steel Cable.



Ai-722 Snake Catcher
90" & 110"
Stainless Steel.



Ai-723 Gentle Giant Collapsible Snake Tong
52", 40", 52", 60", 72".



Ai-724 Gentle Snake Tong Gentle jaws made with fine aluminum
25", 40", 52", 60", 72".



Ai-725 Snake Tong Strong Shaft To Handle Big Reptiles with fine aluminum
25", 40", 52", 60", 72".



Ai-726 Snake Tong Strong Shaft To Handle Big Reptiles with fine aluminum
25", 40", 52", 60", 72".



Ai-727 Snake Tong Strong Shaft To Handle Big Reptiles with fine aluminum
25", 40", 52", 60", 72".



Ai-728 Snake Tong Strong Shaft To Handle Big Reptiles with fine aluminum
25", 40", 52", 60", 72".



Ai-729 Snake Tong
The jaw and handle of this tong is made from best quality aluminum with nice grip.
25", 40", 52", 60", 72".





Ai-730 Snake Tong
The jaw and handle of this tong is made from best quality aluminum with nice grip.
25", 40", 52", 60", 72".



Ai-737 Ideal Snake Hook
18"



Ai-731 Snake Tong
The jaw and handle of this tong is made from best quality aluminum with nice grip.
25", 40", 52", 60", 72".



Ai-738 Snake Hook
16", 24", 38", 45", 48", 55".



Ai-732 Snake Tong
The jaw and handle of this tong is made from best quality aluminum with nice grip.
25", 40", 52", 60", 72".



Ai-739 Snake Hook
This hook is made out of best quality stainless steel. Solid rod with rubber coated tip and nice aluminum handle.
16", 24", 38", 45", 48", 55".



Ai-740 Snake Hook
This pinning hook is made out of best quality steel with nice rubber handle for nice grip.
16", 24", 38", 45", 48", 55".



Ai-733 Snake Hook
traditional snake hook stainless steel material. 100cm, 39.99".



Ai-741 Snake Hook
This Pro field hook is made out of best quality steel with nice rubber handle for better grip.
16", 24", 38", 45", 48", 55".



Ai-734 Professional Snake Hook
45".



Ai-742 Snake Hook
16", 24", 38", 45", 48", 55".



Ai-735 Standard Snake Hook
Stainless Steel 45".



Ai-743 Snake Hook 18" Tight mouth hook
16", 18", 24", 38", 45", 48", 55".



Ai-736 Mini Snake Hook
for small snakes 24"



Ai-744 Snake Hook
This hook is made out of best quality stainless steel. Solid rod with rubber coated tip and nice aluminum handle.
16", 24", 38", 45", 48", 55".

Ai-745

CANINE SPAY SET

- A #3 Knife Handle
- B Mayo Scissors Straight 6-3/4"
- C Metzenbaum Scissors 7" Curved
- D Tissue Forceps 5-1/2", 1x2 Teeth
- E Brown Adson Forceps 4 3/4", 7x7 Teeth
- F Halsted Mosquito Forceps 5" Curved
- G Kelly Forceps 5-1/2" Curved
- H Roch-Carmalt Forceps 6-1/4" Cvd. + Str.
- I Backhaus Towel Clamp 3-1/2"
- J TC Olsen Hegar Needle Holder 6-1/2" TC
- K Allis Tissue Fcp 4x5 Teeth 6"
- L Snook Ovariectomy Hook

Ai-746

FELINE SPAY SET

- A #3 Knife Handle
- B Mayo Scissors Straight 6-3/4"
- C Metzenbaum Scissors 7" Curved
- D Tissue Forceps 5-1/2", 1x2 Teeth
- E Brown Adson Forceps 4 3/4", 7x7 Teeth
- F Halsted Mosquito Forceps 5" Curved
- G Kelly Forceps 5-1/2" Curved
- H Roch-Carmalt Forceps 6-1/4" Curved
- I Backhaus Towel Clamp 3-1/2"
- J TC Olsen Hegar Needle Holder 5-1/2" TC
- K Allis Tissue Fcp 4x5 Teeth 6"
- L Snook Ovariectomy Hook

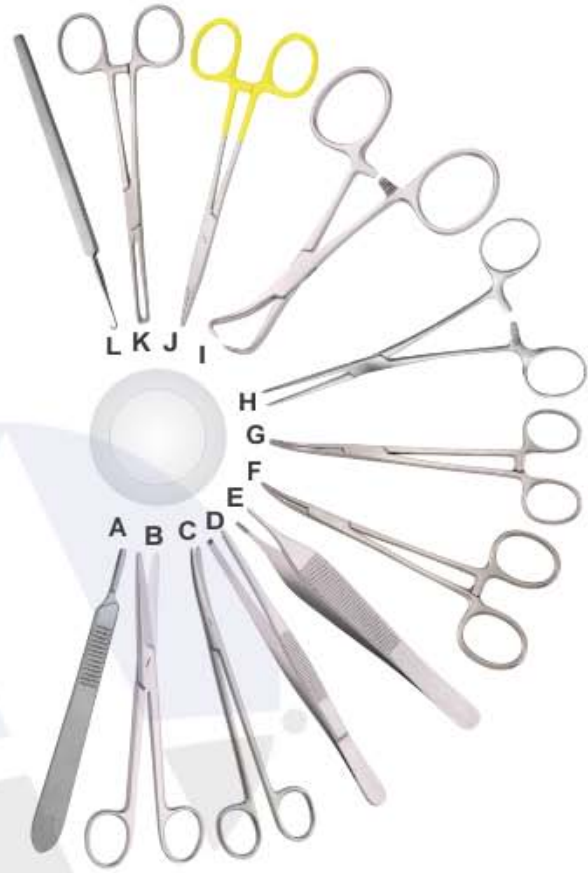

Ai-747

GENERAL SURGERY SET

- A #3 Knife Handle
- B Mayo Scissors Straight 6-3/4"
- C Metzenbaum Scissors 7" Curved
- D Tissue Forceps 5-1/2", 1x2 Teeth
- E Brown Adson Forceps 4 3/4", 7x7 Teeth
- F Halsted Mosquito Forceps 5" Curved
- G Kelly Forceps 5-1/2" Curved
- H Roch-Carmalt Forceps 6-1/4" Curved
- I Backhaus Towel Clamp 3-1/2"
- J TC Olsen Hegar Needle Holder 5-1/2" TC
- K Snook Ovariectomy Hook
- L Allis Tissue Forceps 6", 5 X 6 Teeth
- M Sen Retractor
- N Suture Scissors, 8", sharp-Blunt

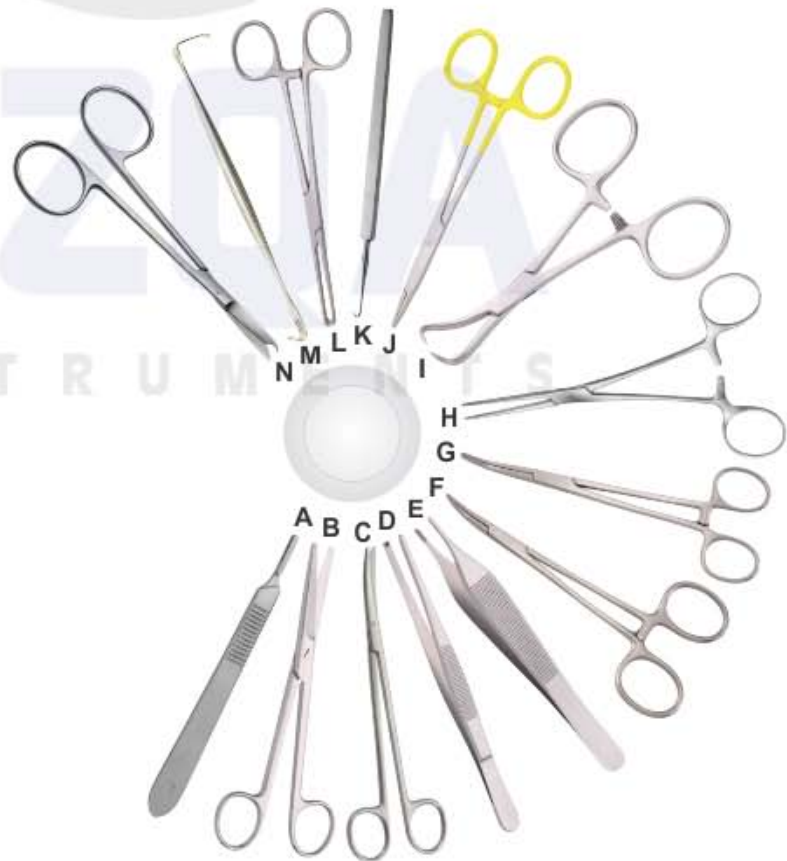

Ai-748

Exotic Animal Surgical Kit
Kit includes:

- (1) Scissors, Surgical, 5.5"
- (1) Instrument Case, Sterilizing Boxes (with silicon Pads)50x152mm
- (1) Retractor, ALM Self-Retaining
- (1) Forceps, Dressing 12.5 cm straight
- (1) Scissors, Iris, 11 cm, straight tungsten carbide blades
- (1) Needle Holder, Olsen Hegar, with suture scissors
- (1) #3 Scalpel handle
- (1) Forceps, Micro Adson 12 cm
- (2) Forceps, Mosquito 3.5" curved
- (2) Forceps, Hartman Mosquito 3.5"



Ai-749

Mouse Vessel Cannulation Kit

- Instrument Case, Sterilizing Boxes (with silicon Pads)50x152mm
- Dumont Tweezers #5
- Vannas Scissors
- Alm Self-Retaining Retractor
- Fine, Serrated Forceps
- MicroFil, 28 gauge
- Vessel Cannulation Forceps, 0.5 mm Diameter



Ai-750

General Surgery Basic Kit
Kit includes:

- (1) #3 Scalpel handle
- (1) Mayo scissors, 6.75", straight
- (1) Snook ovariotomy, 7"
- (3) Mosquito hemostatic forceps, 5", curved
- (2) Kelly hemostatic forceps, 5.5", straight
- (1) Metzenbaum scissors, curved, 7"
- (1) Brown-Adson forceps, 7x7 teeth
- (4) Rochester Carmalt forceps, 6.25", curved
- (4) Backhaus towel clamps, 5.25"
- (1) Olsen Hegar needle holders, 5.5"
- (1) Sterilization case



Ai-751

Rat Dissecting Kit

- Dumont Tweezers #5
- Alm Self Retaining Retractor
- Vannas Scissors
- Needle Holder
- Iris Forceps, Curved, Serrated
- Blunt Probe, 1.0 mm Diameter
- SuperCut Iris Scissors, Straight, 10 cm



Ai-752

Feline Spay Pack
Kit includes:

- (2) Kelly forceps, 5.5", curved
- (2) Kelly hemostatic forceps, 5.5", straight
- (2) Mosquito hemostatic forceps, 5", curved
- (2) Mosquito forceps, 5", straight
- (3) Jones towel clamp, 3.5"
- (1) Dressing forceps, 5.5"
- (1) #3 Scalpel handle
- (1) Adson Brown forceps, 4.75"
- (1) Mayo scissors, 6.75", straight
- (1) Mayo-Hegar needle holder, 6.75"
- (1) Olsen-Hegar needle holder, 6.5"
- (1) Snook ovariotomy, 7"



Ai-753

Micro-surgical Kit
Kit includes:

- (1) Tweezers, Dumont #5, 11cm non-magnetic stainless steel
- (1) Scissors, Spring, 14 cm curved
- (1) Needle Holder, Castroviejo 14 cm
- (1) Scissors, Tenotomy, 10 cm straight
- (1) Instrument Tray, autoclavable
- (2) Forceps, Micro Hemostatic, 12.5 cm, curved
- (1) Knife Handle, Round Knurled
- (1) Blades, Miniature Edge 12-pack
- (1) Probe, 14 cm, stainless steel (not pictured)
- (1) Retractor, Weitlaner, 10.8 cm



Ai-754
Mouse Dissecting Kit

- Dumont Tweezers #5
- Wire Retractor
- Vannas Scissors
- Needle Holder
- Iris Forceps, Curved, Serrated
- Blunt Probe, 1.0 mm Diameter
- Dissecting Scissors, 10 cm, Straight
- Small Surgical Instrument Storage Portfolio



Ai-755
Student Botanical Kit

- 1 Scissors, 14cm
- 1 Dropper
- 1 Scalpel Handle #3
- 4 Scalpel Blades
- 1 Teaser Needle, Angled
- 1 Teaser Needle, Straight
- 1 Mariam Tweezers, Angled
- 1 Tweezers, Straight
- 1 Instrument Storage Portfolio



Ai-756

Physiology II Kit

- Vannas Scissors
- Stevenson Retractor
- SuperCut Iris Scissors, Straight
- Iris Forceps, Curved, Serrated
- Rongeur 1.3 mm Jaw
- Adson Forceps, 1 x 2 Teeth
- Utility Scissors, Straight, Sharp/Blunt
- Olsen-Hegar Needle Holder
- Probe 1.0mm Diameter, Blunt
- Dumont Tweezers #5
- Operating Scissors, Straight, Sharp/Blunt
- Instrument Storage Portfolio



Ai-757

Entomology Kit for Students

Kit Contains:

- 2 Teaser Needles, Straight
- 2 Teaser Needles, Angled
- 1 Iris Scissors, 11.5 cm
- 1 Scalpel Handle #3
- 1 Adson Micro Forceps, 12 cm
- 1 Dropper
- 2 Micro Dissection Forceps, 12 cm, Straight
- 2 Micro Dissection Forceps, 12 cm, Curved
- 2 Entomology Forceps, 10 cm
- 1 Tweezers with Magnifying Mirror
- 1 Stainless Steel Ruler, 6"
- 10 Blades #10
- 1 Instrument Storage Portfolio



Ai-758

Dissection Kit for Students

Kit Contains:

- 1 Scalpel Handle #3
- 1 Scalpel Handle #4
- 1 Dressing Forceps, 16 cm
- 1 Mayo Hager Needle Holder, 16 cm
- 1 Teaser Needle, Angled
- 1 Teaser Needle, Straight
- 1 Hooks with Chain
- 1 Tissue Forceps, 1:2, 16 cm
- 1 Dissecting Scissors, 16 cm, Sharp/Blunt
- 1 Kelly Forceps, 14 cm, Straight
- 1 Dropper
- 1 Stainless Steel Ruler, 6"
- 1 Grooved Director, Plain
- 1 Adson Tissue Forceps, 12 cm
- 4 Blades for Scalpel Handle #4
- 4 Blades for Scalpel Handle #3
- 1 Surgical Instrument Portfolio



Ai-759

Veterinary Periodontal Surgery Basic Kit
Kit includes:

- (1) 503413 - Mirror, Cone socket
- (1) 503414 - Double end explorer
- (1) 503415 - Periodontal probe
- (1) 500236 - #3 Scalpel handle
- (1) 503417 - 1 Ochsenbein chisel
- (1) 503419 - Kirkland gum knife
- (1) 503420 - Orban scaler
- (1) 503421 - Jacquette scaler #1SSE
- (1) 503422 - Gracey curettes #11-12
- (1) 503423 - Scaler, double-ended
- (1) 503424 - Gracey curettes #13-14
- (1) 503406 - Periosteal elevator, double-ended



Ai-760
Student Veterinary Kit

Dissecting scissors, 4.5"
Dissecting scissors, 4"
Dressing forceps, 5.5"
Micro dressing forceps, 4"
#4 Knife handle
Straight teasing needle
Angled teasing needle
#22 Surgical blade
Canvas roll-up



Ai-761
Sterilization Mesh Cassette,
4 x 4 x 2 cm (1.5 x 1.5 x .75")



Ai-762
Sterilization Mesh Cassette,
8 x 8 x 3.4 cm (3.1 x 3.1 x 1.4")



Ai-763
Sterilization Mesh Cassette,
10.5 x 7 x 2.5 cm (4.1 x 2.75 x 1")

Ai-764

CASTRATION EMASCULATORS INSTRUMENTS

- A WHITE Emasculator 12"
- B PLAIN Emasculator 12"
- C FRANK Emasculator 9"
- D Small WHITE Emasculator

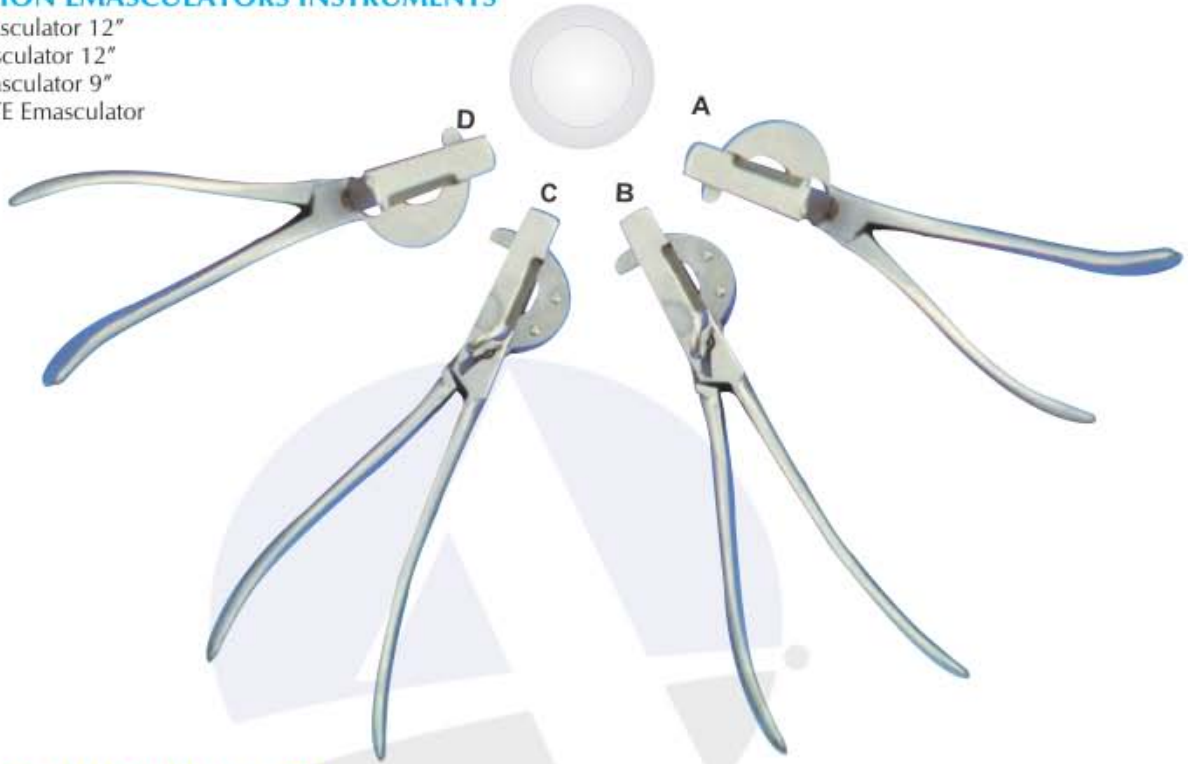

Ai-765

STANDARD VETERINARY EYE SET

- A #3 Scalpel Handle
- B Wire Eye Speculum
- C Eye Dressing Forceps 4"
- D Chalzion Forceps
- E Stevens Tenotomy Scissors 4-1/8"
- F Castroviejo Needle Holder 5-1/2" Str.
- G Bishop-harman, Toothed Forceps
- H Baby Olsen-hegar N/Holder Tc Tip
- I Desmarres Retractor



Ai-766

STANDARD VETERINARY ORTHOPEDIC INSTRUMENT SET

- A** Wire Cutter
- B** Senn Retractor Blunt 6 3/8" (16.2cm), blunt prongs, double end
- C** Senn Retractor Sharp 6 3/8" (16.2cm), sharp prongs, double end
- D** Weitlaner Retractor 5 1/4" (13cm)
- E** Freer Elevator 7" (17.8cm) double end, sharp and blunt blades
- F** Bone Curette
- G** Mallet
- H** Bone File
- I** Wire twister 6" (15.2) with Carb-N-Sert jaws
- J** Kern Bone Holding Forceps Small 6 1/2" (15.2cm), with ratchet
- K** Kern Bone Holding Forceps Large 9 1/2" (24.1cm), with ratchet
- L** Bone Cutting Forceps
- M** Pin Cutter
- N** Osteotome



Ai-767

SPECULA

- A VIENNA Nasal Speculum, 5-3/4" (14.6cm), standard pattern, 1-1/8" (2.8cm) blades
- B VIENNA Nasal Speculum, 5-3/4" (14.6cm), standard pattern, 1-1/8" (2.8cm) blades (Vantage Brand)
- C VIENNA Nasal Speculum, 5-3/4" (14.6cm), light pattern, 1-1/8" (2.8cm) blades
- D KILLIAN Speculum, 6" (15.2cm), with set screw, 3-1/2" (8.9cm) blades
- E GRAVES Vaginal Speculum, 3-3/4" (14.6cm), small
- F GRAVES Vaginal Speculum, 3-3/4" (14.6cm), small (Vantage Brand)



Ai-768

ABDOMINAL PACK SET

- A Balfour Retractor
- B Baby Balfour Retractor
- C Central Blade Only
- D De Bakey Forceps
- E Doyen Intestinal Clamps
- F Metzenbaum Scissor 18cm
- G T/c Olsen Hegar Needle Holder 18cm
- H Poole Suction Tube.

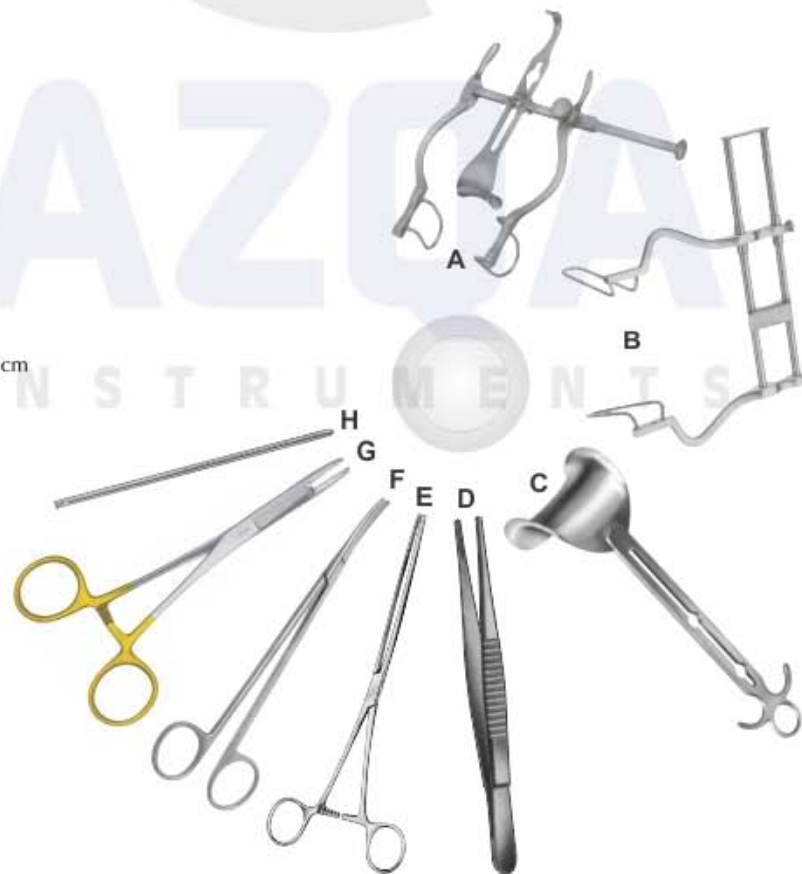

Ai-769

NEUTER PACK SET

- A Halstead Mosquito 12cm
- B Crile Wood N/holder Tc
- C Allis Tissue Forceps
- D Backhaus Towel Clips
- E Olsen-Hegar N/Holder
- F Metzenbaum Scissors
- G Adson Tissue Forceps
- H Scalpel Handle No.3 with scale

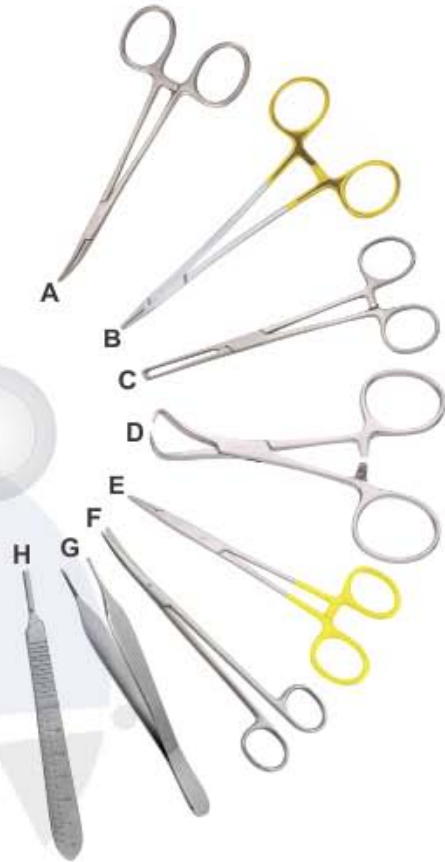

AZQA
INSTRUMENTS

Ai-770

CRUCIATE PACK SET

- A Baby Gelpi
- B Martin Cartilage Forceps
- C Deschamps Needle right small or large
- D Smilie Menisectomy Knife
- E Mini-Hohlmann
- F Hohmann Retractor



Ai-771

CRUCIATE PACKS SET

- | | |
|---|---|
| <ul style="list-style-type: none"> A Knife Handle, 10cm B Mayo Scissor 6.75" straight C Roger Wire Cutting Scissor 4.75" D Frazier Suction 10fr E Halsted-Mosquito Forceps 5" straight F Halsted Mosquito Forceps 5" curved G Crile Forceps 5.5" straight H Adson-Brown Forceps 4.75" I Olsen-Hegar Needle Holder 6.5" | <ul style="list-style-type: none"> J Senn Retractor 6.25" (3 sharp prongs) K Mini Hohmann Retractor 6mm L Lempert Rongeur 6.5" curved M Wire Cutter T.C 14cm N Complete Hand Chuck Pin 3/32" smooth O Crimping Device P Tensioning Device Q Crimp Tubes R Cruciate Needles (set of 3 sizes) 80# S Monofilament Nylon Suture T Tray, Stainless Perforated |
|---|---|



Ai-772

VETERINARY EXTRACTION BASIC SET-

- A** #3 Scalpel Handle
- B** Baby molt Periosteal Elevator
- C** Extracting Forceps
- D** Universal, mini, La Grange Scissors 4 1/4"
- E** Olsen-Hegar Needle Holder Combined suture scissors 5 1/2"
- F** Brown- Adson Tissue Forceps, 4 3/4"
- G** Operating Scissors Straight 5 1/2"
- H** Luxating Elevator Straight & Curved 2mm
- I** Luxating Elevator Straight & Curved 3mm
- J** Luxating Elevator Straight & Curved 5mm



Ai-773

SPAYING & TEAT INSTRUMENTS

- A COVAULT Ovariectomy Hook with probe tip, 8-1/4"
- B SNOOK Ovariectomy Hook, 8"
- C SNOOK Ovariectomy Hook, 8"
- D UDALL Teat Bistouri, 6-1/4", blunt
- E LICHTY Teat Knife, 5-1/2", sharp point
- F LICHTY Teat Knife, 5-1/2", blunt end
- G CORNELL Teat Curette, 6-1/4"
- H BOWER Obstetrical Forceps, 9-1/2", Straight, serrated jaws
- I BOWER Obstetrical Forceps, 9-1/2", curved, serrated jaws



Ai-774

CANINE PERIODONTAL SET

- A Mirror Handle Cone Socket
- B Mirror #4
- C Explorer 2
- D Probe 20-23 Explorer
- E Curette Columbia 13-14 Fine
- F Curette Columbia 4L-4R
- G Snook Ovariectomy Hook



Ai-775

GROOMING INSTRUMENTS

- A White Toenail Scissors 4-1/2"
- B Tissue & Cuticle Nipper 4" Convex Jaws
- C Tissue & Cuticle Nipper 4-1/2" Convex Jaws
- D Tissue & Cuticle Nipper 5" Convex Jaws
- E Tissue & Cuticle Nipper 5" Convex Hvy Pattern
- F Fetlock Clipper
- G Set of 2 Blades for Fetlock Clipper
- H Wing Nut for Fetlock Clipper



Ai-775

CANINE & FELINE TARTER SCRAPERS

- A Canine & Feline Tartar Scrapers Claw Type
- B Canine & Feline Tartar Scrapers Curved w Straight Edge
- C Canine & Feline Tartar Scrapers Angular, Pointed
- D Canine & Feline Tartar Scrapers Triangular
- E Canine & Feline Tartar Scrapers Curved w Angled Edge
- F Canine & Feline Tartar Scraper DE, Cvd w Angled Edges
- G Universal Scaler #12 - Double Ended, Solid
- H Towner Scaler #15 - Single Ended, Solid
- I Towner Scaler #15/33 - Double Ended, Solid
- J Universal Scaler #3 - Single Ended, Solid
- K Universal Scaler #33 - Single Ended, Solid
- L Universal Scaler #34 - Single Ended, Solid
- M Tartar Remover 4.5" Small
- N Tartar Remover 5.5" - Large



Ai-776

RESTRAINT INSTRUMENTS

- A Petite Mouth Gag 2-1/4" Lightweight
- B Feline Mouth Gag 3" Lightweight
- C Canine Mouth Gag 4" Small Size
- D Canine Mouth Gag 4" Medium Size
- E Canine Mouth Gag 6-3/4" Large Size

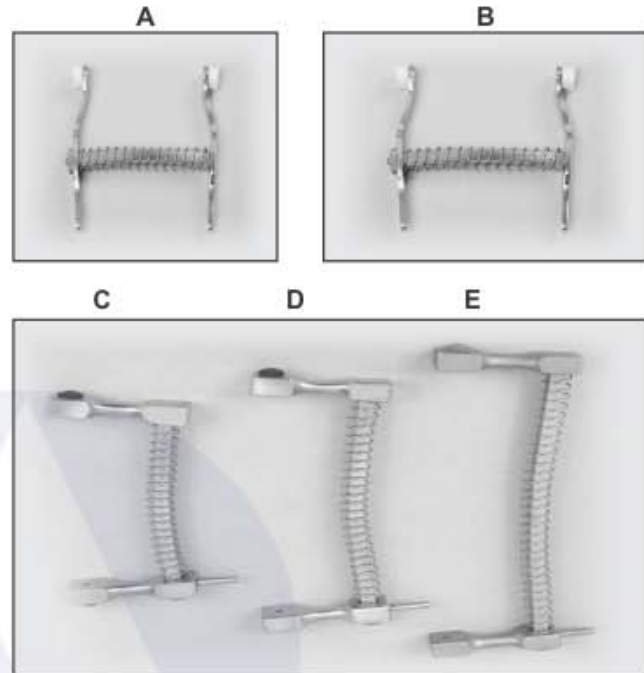

Ai-777

VETERINARY PERIODONTAL BASIC KIT -MEDICAN

- A Mirror Handle Complete
- B Probe/Explorer CP 12/23
- C Tower-Jaquette Scaler
- D Gracey Anterior Curette
- E Gracey Posterior Curette
- F Columbia Curette
- G Large Surgical Elevator
- H Small Surgical Elevator
- I Extra Surgical Elevator



CURETTES, SCALERS & PROBES



Ai-778 Jacquette Scaler #1S/1S (33/33) Solid



Ai-779 Jacquette Scaler #2S/3S (34/35) - Solid



Ai-780 Jacquette Scaler #2/3 (31/32) - Solid



Ai-781 Gracey Curette #11/12 - Solid



Ai-782 Gracey Curette #13/14 - Solid



Ai-783 Columbia Curette #13/14 - Solid Handle



Ai-784 McCall Curette #13/14 - Solid



Ai-785 Goldman-Fox Probe - Flat, Single Ended



Ai-786 Expro #23/Williams



Ai-787 Williams Probe



Ai-788 Williams/Fox Probe - Double Ended



Ai-789 Holmstrom Plugger/Spreader #90 - 45mm

Ai-790

DENTAL PACK SET

- A** Winged Elevators
- B** Dental Extracting Forceps
- C** Root Elevator 76N
- D** Explorer D/E
- E** Curettes Columbia 13-14
- F** Curettes Columbia 4L-4R
- G** Scaler, Jacquette 2S-3S
- H** Periosteal Elevator
- I** T/c N/Holder



Ai-791

RODENT PACK SET

- A Mouth Gag
- B Check Retractors
- C Tooth Cutter
- D Tooth Extracting Forceps
- E Spatula
- F Molar Luxator 3mm
- G Incisor Luxator 5mm
- H Curettes



Veterinary Winged Dental Elevators

winged elevators are light-weight yet extremely durable. The sharp, tapered winged tip allows easy insertion into the PDL. The width of the winged tips have been shaped to match the size and shape of the tooth's root structure (sizes 1-6 mm). This unique winged shape increases control of the instrument and provides additional leverage to aid in extraction of the tooth.

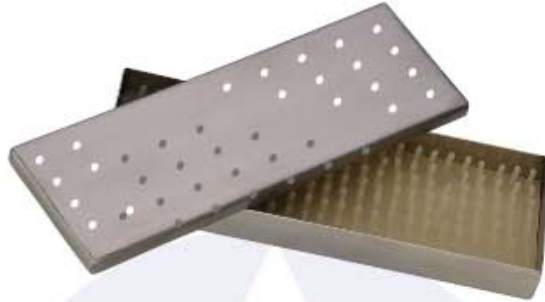

Ai-792

Winged Elevators with Standard Handle

Winged Elevator 1mm



Winged Elevator 2mm



Winged Elevator 3mm



Winged Elevator 4mm



Winged Elevator 5mm



Winged Elevator 6mm



Straight Root Tip Pick

Used for assisting with extraction of retained root tips or root fragments.
Straight Root tip pick - stubby handle



Periosteal Elevator

Used for elevating the muco-periosteal flap during extractions on large breed dogs.
Periosteal Elevator - stubby handle



Winged Elevators with Stubby Handle

The stubby handle elevators available as a 6 pc. set. See page 16

Winged Elevator 1mm



Winged Elevator 2mm



Winged Elevator 3mm



Winged Elevator 4mm



Winged Elevator 5mm



Winged Elevator 6mm



Ai-793

6 pc Stubby Handle Set includes
stainless steel instrument holder/case

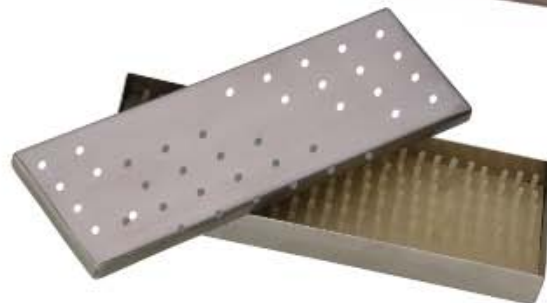

AI-794 5pc Luxator instrument set (1-5mm Stubby)

1mm Luxator (Stubby Handle)



2mm Luxator (Stubby Handle)



3mm Luxator (Stubby Handle)



4mm Luxator (Stubby Handle)



5mm Luxator (Stubby Handle)



Luxators

Luxators, sizes 1-5mm are very fine and sharp. The 5 sizes allow their use for both feline and Canine teeth. They are used and recommended by dental specialist's for cutting the periodontal ligament and expanding the alveolus (tooth Socket) and are ideal for incisors and crowded teeth.

The stubby (shorter length and larger diameter) handle makes extraction so much safer as the users fingers can be placed at the instrument tip. Luxators are not elevators, we recommend winged elevators are used to elevate and extract the tooth.



Ai-795

Explorer/Measuring Probe

The probe end has periodontal markings etched in black. The fine but robust tip is ideal for periodontal probing in cats or dogs. The markings will not fade even after many autoclave cycles. The other end of the probe has a shepherd hook explorer to detect tooth defects both supra and subgingivally.



Ai-796

Double Ended Periosteal Elevator

The periosteal elevator is used to lift a muco-periosteal flap off the bone when performing surgical extractions. The fine double-ended 2/4 periosteal elevator is great for cats and small to medium dogs.



Ai-797

Sickle Scaler

This scaler is used to remove plaque and calculus from the tooth surface. The sickle scaler tip can be used to remove calculus from the developmental grooves and blood grooves in canine teeth.



Ai-798

Jaquette Supragingival Scaler

(Above the gum) The scaler is used to remove plaque and calculus from the tooth surface. It works well in tight occlusal spaces.



Ai-799

Subgingival Curette

(Below the gum) The curette is used to clean plaque and calculus from the tooth root surface.



AZQA
INSTRUMENTS



Ai-800

Minnesota Retractor

Used to lift and protect the tissue and the user when performing surgical extractions whilst operating the high speed drill. One end holds the cheek back and the other holds the tongue down, a multi purpose retractor.



Ai-801

Tartar Removing Forceps

The curved beak of the forceps allow for easy removal of heavy calculus from the tooth surface, decreasing the chance of fracturing the tooth.



Ai-802

Extraction Forceps

Extraction forceps are used to grasp the tooth and remove from the socket after it is loosened. The small size and spring in the handle helps prevent excessive force and the risk of breaking the tooth. Overall length 125mm (5").



Ai-803

Root Tip Extraction Forceps

Root tip extraction forceps have grooved tips with fine curved ends that meet when closed. They are ideal for root extraction or as an alternative to regular extraction forceps (D1012). 6" / 150mm.



Ai-804

Fragment Extraction Forceps

Root fragment forceps are ideal for extracting mobile broken root fragments and small, delicate teeth. The grooved and serrated jaws assist with grasping fragments. 5 1/2" / 138mm.



Instruments Specially Designed for Felines and/or Very Small Dogs



Straight Tip Elevators

These super slim elevators are excellent for removing teeth in cats and small dogs. They are also useful in retrieving fractured roots. Tips can be sharpened using a dental stone.



Elevator 1mm

1mm wide straight tip elevator with stubby handle.

Elevator 2mm

2mm wide straight tip elevator with stubby handle.



Probe/Explorer

The probe end has periodontal markings etched in black. The fine but robust tip is ideal for periodontal probing in cats or dogs. The markings will not fade even after many autoclave cycles. The other end of the probe has a shepherd hook explorer to detect tooth defects both supra and subgingivally.



Very Fine Periosteal Elevator

Double ended elevator. The small delicate flat ends of this instrument make it ideal for raising gingival flaps in cats. The rounded tip helps prevent accidental slippage and tearing of the gingival flap.



Resorptive Lesion Probe

This probe can be used to detect resorptive lesions or residual calculus subgingivally. The probe can also be used to identify furcation involvement (loss of alveolar bone between tooth roots).



Sickle Scaler

This double ended hand instrument is used for the removal of supragingival (above the gum) plaque/calculus and stains.



Curette

This slimline curette is ideal for calculus and plaque removal both supra and subgingivally (above and below the gum). The fineness of the instrument is well suited for use in cats and small dogs.



Extraction Forceps

Extraction forceps - small. These fine extraction forceps are designed to grasp small teeth. The spring action allows their use without excessive force being applied to the tooth crown. 125 mm

Ai-805

Instruments mentioned on this page are available as a set .





Curved Deciduous Elevators

The curved deciduous elevators are ideal for the removal of retained canines (milk teeth) and are available in three sizes suitable for the different sized deciduous teeth encountered.

The sharp elevator end cuts the PDL whilst the curve of the elevator tip follows the mesial curve and the other end the distal curve of the root. Curved deciduous elevators make the removal of retained teeth quick and easy because they follow the curve of the root.

Ai-806
Curved Deciduous Elevator – Small (2mm)



Ai-807
Curved Deciduous Elevator – Medium (3mm)



Ai-808
Curved Deciduous Elevator – Large (4mm)



Ai-809
Molt Periosteal Elevator – No. 9

The rounded edge of the periosteal instrument minimise the tearing of tissue when lifting the gum flap. The sharp end makes the initial lifting of the flap easier. Suitable for medium to large dogs.



Ai-810
Small Dog or Cat Right Angle Extraction Forceps

Designed by for easier extraction of cat, small dog and deciduous teeth. Parallel right angle jaws reduce the risk of tooth fracture during extraction. By not meeting at the end, they reduce the risk of breaking off cats teeth. Small handles provide a more tactile feel.



Instrument Sets

Instrument sets take the guess work out of choosing the correct dental instrument. Instruments are used throughout the world in teaching wetlabs and have been developed with the help of veterinary dental specialists. Made from high quality stainless steel, these instruments meet the needs of the modern day veterinarian.

Ai-811

5 Piece Specialised Instrument Set

The set is intended as a supplement to ordinary tooth extraction sets. The curved deciduous elevators are ideal for the removal of retained canines (milk teeth). Each instrument is available individually.

The set consists of:

- Molt Periosteal Elevator - No 9
- Curved Deciduous Elevator - small
- Curved Deciduous Elevator - medium
- Curved Deciduous Elevator - large
- Extraction Forceps, right angled jaw



Ai-812

14 Piece Instrument Set, Standard Handle Elevators

The set consists of:

- Winged elevators Size 1-5mm
- Straight root tip pick
- Tartar Removing Forceps
- Extraction Forceps
- Minnesota Retractor
- Subgingival Curette
- Jaquette Supragingival Scaler
- Sickle Scaler
- Explorer / Measuring Probe
- Double ended Periosteal Elevator
- Each instrument is available individually



Ai-813

14 Piece Instrument Set, Stubby Handle Elevators

The set consists of:

- Winged elevators Size 1-5mm
- Straight root tip pick
- Tartar Removing Forceps
- Extraction Forceps
- Minnesota Retractor
- Subgingival Curette
- Jaquette Supragingival Scaler
- Sickle Scaler
- Explorer / Measuring Probe
- Double ended Periosteal Elevator
- Each instrument is available individually



Ai-814

Feline 8 Piece Instrument Set

The feline periodontal kit has been designed exclusively for use in cats and small dogs. Its design allows the practitioner to perform a complete oral examination (including detection of feline resorptive lesions) and cleaning of all tooth surfaces – both supra and subgingivally. All instruments are available individually.

The set consists of:

- 1 mm Wide Straight Tip Elevator,
- 2 mm Wide Straight Tip Elevator
- Probe/Explorer
- Extraction Forceps
- Periosteal Elevator
- Resorptive Lesion Probe
- Sickle Scaler and Curette.



Ai-815**4 Piece Winged Elevator Set**

Winged Elevator sizes 1-4 mm in standard handle, supplied in a black pouch. Each elevator is available individually.

Standard Handle Set

**Ai-816****4 Piece Winged Elevator Set**

Winged Elevator sizes 1-4 mm in stubby handle, supplied in a black pouch. Each elevator is available individually.

Stubby Handle Set

**Ai-817****6 Piece Winged Elevator Set**

Winged Elevator sizes 1-6 mm in standard handle, supplied in a black pouch. Each elevator is available individually.

Standard Handle Set

**Ai-818****6 Piece Winged Elevator Set**

Winged Elevator sizes 1-6 mm stubby (shorter length and larger diameter) handle. The stubby handle makes extraction so much safer as the user's finger can be placed at the instrument tip. The new handle design is ideal for small or large hands. Supplied in a black pouch. Each elevator is available individually.

Stubby Handle Set



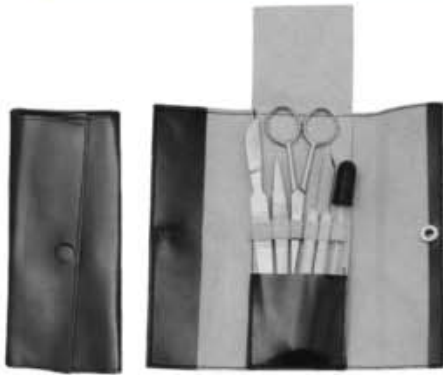

Ai-819

Basic Dissecting Set

A Collection of Instruments For Introductory Dissection vinyl pouch
 Scalpel 6" Scissors 4 1/2" Forceps student grade 4 1/2"
 Straight needle in Wooden Handle Bent needle in wooden handle
 Medicine Droppers.

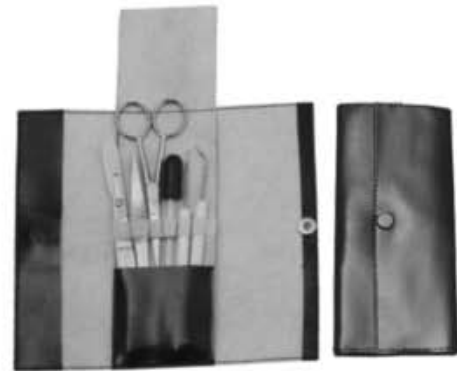

Ai-820

Dissecting Set

Beginners For Elementary Junior High Or High School Life Science
 Vinyl pouch Scissors Forceps student /Scalpel with Replaceable
 blade Straight needle in wooden handle Bent needle in wooden
 handle Medicine dropper



Ai-821

General Biology Dissecting Set

Designed for work in general biology good Quality instruments
 scissor student Forceps fine point 4 1/2" S/S
 Scalpel 1 1/2" Blade (with G pin S/S)
 Straight Needle with wooden handle Medicine Dropper
 single fold leatherette case.



Ai-822

Fine Dissecting Set

Designed for Freshman Courses in Biology
 Scissors Fine point 4 1/2" Forceps fine point with g pin 4 1/2"
 Scalpel replaceable Blade Teasing Needle Str
 Teasing Needle Cvd Medicine Dropper
 Single Fold Leatherette Case.



Ai-823

Intermediate Dissecting Set

Contains high quality instruments recommended for advance
 biology courses . Scissor surgical 4 1/2" Forceps fine point 4 1/2 "
 Surgeon scalpels (with # 22 blade) Teasing needle plastic handle Str
 Teasing needle Cvd Plastic handle Mall probe and seeker
 Medicine dropper Single fold leatherette case



Ai-824

Tissue Culture Dissecting Set

Features Stainless Steel Instrument in leatherette case
 Scissors M/Dissecting Iris 4 1/2 " Forceps watchmaker 4 1/4"Str
 Forceps watchmake 4 1/4" Cvd Scalpel micro dissecting 5"
 18x3 mm blade Teasing Needle Str S/S Teasing Needle Cvd S/S
 Single Fold leatherette case



AI-825

Anatomy Dissecting set

A complete set Detailed Dissection for more advanced work in zoology and comparative anatomy .

Surgical scissors 5 ½". Fine point scissors 4 ¼ "

Forceps fine point Cvd 4 ½ " Thumb forceps superior 5" Scalpel 1 ½" Blade .

Cartilage knife/Flexible Probe. Triple chain Hook/Mall probe.

Needle wooden handle Str. Needle wooden handle Str

Medicine Dropper. Double fold leatherette case



AI-826

Graduate Dissecting Set

Design for the biology graduate students

Surgical scissors 5 ½". Fine point scissors 4 ½".

Forceps fine point Str 4 ½" Forceps fine point Cvd 4 ½".

Triple chain hook. cartilage knife scalpel stain finish 1 ½" blade

forceps cartilage 5" 2 needle holder with straight needle .

Flexible probes. Probes with hook. Probe & seeker

Dropping Pipe Double Fold Leatherette case



AI-827

Micro Dissecting Set

Feature stainless steel Instruments in Leatherette case.

Scissors M/Dissecting Iris 4 ½" Scissors sharp point Iris 4 ½"

Forceps Micro Dissecting 4 1/4" Straight Forceps micro dissecting 4"

Curved Scalpel micro dissecting 18 x 3 mm blade

scalpel micro dissecting 30 x 3 mm blade Dissecting needle Str .

Dissecting needle Cvd. Dissecting needle Full-Spear point

Dissecting needle Half-Spear point In double folding case.



AI-828

Large Animal set

This set provide all the Necessary instruments Dissection of large Animal such as Cat, Shark and Rabbits Scissor surgical 5 ½ "

D/Scissors superior 4 ½ " Scissors fine point Str 4 ½ "

Forceps large Tissue 1x2 teeth 6" Forceps utility Cvd point 6" .

Forceps fine point str 4 ½" Scalpel screw Lock with # 22 blade .

Knife cartilage 6 ½ ". Probe sharp point angular. Section lifter S/S

Teasing needle Str Wooden handle. Teasing Needle Cvd Wooden handle

Medicine dropper.



Ai-829
RANGE OF SPATULAS
 7 parts filled, in a case with press stud
 Content
 1 straight blunt tweezers, 145 mm
 1 micro double spatula, 150/4 mm
 1 double spatula, 150/9 mm
 1 micro-powder spatula, 150/4 mm
 1 powder spatula, 150/9 mm
 1 micro-spoon spatula, 150/5 mm
 1 micro-spoon spatula, 150/7 mm



Ai-830
Jewellery Forceps Set



Ai-831
DISSECTING SET
 6 parts or 12 parts filled, in pouch
 Content
 1 powder spatula, 150/9 mm
 1 straight scissors, 100 mm
 1 spoon spatula, 150 mm
 1 scalpel 125 mm
 1 flexible section lifter, 150 mm
 1 pointed tweezers, 130 mm



Ai-832
Needle Set

Ai-833
BOWMAN LACRIMAL PROBES
 Double Ended, Sterling Silver

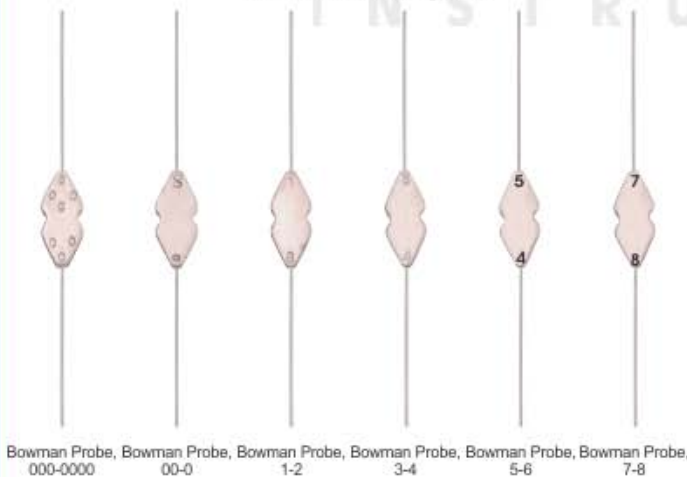

Bowman Probe, Bowman Probe, Bowman Probe, Bowman Probe, Bowman Probe, Bowman Probe,
 000-0000 00-0 1-2 3-4 5-6 7-8

Ai-834
WILLIAM LACRIMAL PROBES
 Double Ended, Sterling Silver

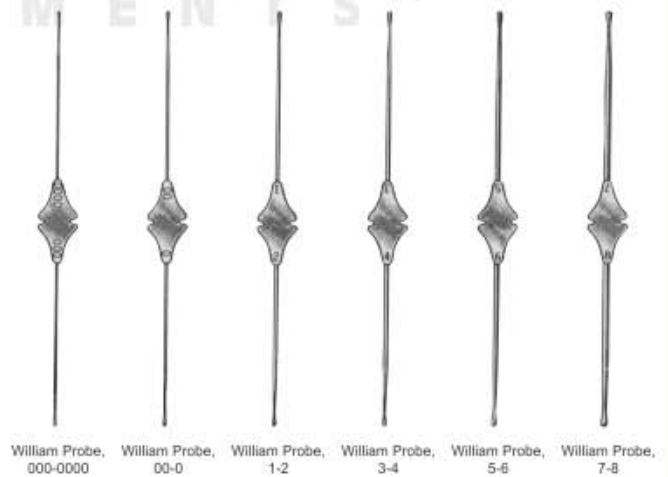

William Probe, William Probe, William Probe, William Probe, William Probe, William Probe,
 000-0000 00-0 1-2 3-4 5-6 7-8



AI-835
Fish Aquarium Set



AI-836
Fish Aquarium Set



AI-837
Fish Aquarium Set



AI-838
Fish Aquarium Set



AI-839
Fish Aquarium Set



AI-840
Fish Aquarium Set



Ai-841



Ai-842



Ai-843



Ai-844

I N S T R U M E N T S



Ai-845
Dissection Premium Kit

Ai-846

DRESSING SET - 8 PIECES

- Kidney Dish 20 cm (8") - medium
- Gallipot 150 ml - 6 oz - medium
- Kocher artery forceps - straight - 16 cm
- Dressing Forceps (Thumb) - 16 cm
- English TOE dissecting forceps - plain - 14 cm
- Mayo scissors - straight - 15 cm
- Rampléy sponge holding forceps - str. - 18 cm
- Instrument tray with lid 25x30x6.2 cm



Ai-847

SUTURE SET - 12 PIECES

- Kidney Dish 20 cm (8") - medium
- Gallipot 150 ml - 6 oz - medium
- Mayo Hegar needle holder - 18 cm
- Kocher artery forceps - straight - 16 cm
- Kocher artery forceps curved - 16 cm
- Dressing Forceps (Thumb) - 16 cm
- English TOE dissecting forceps - plain - 14 cm
- Dissecting forceps toothed 1x2 - 14 cm
- Suture scissors - Heaths Ligature - 15 cm
- Mayo scissors - straight - 15 cm
- Rampléy sponge holding forceps - str. - 18 cm
- Instrument tray with lid 30x20x5 cm



Ai-848

MINOR DELIVERY SET - 25 PIECES

- Kidney Dish 20 cm (8") - medium
- Kidney Dish 25 cm (10") - large
- Gallipot 150 ml - 6 oz - medium
- Brown Sadler episiotomy scissors - 14 cm
- Kocher artery forceps - straight - 16 cm
- Kocher artery forceps straight - 18 cm
- Kocher artery forceps curved - 16 cm
- English TOE dissecting forceps - plain - 14 cm
- English TOE dissecting forceps - plain - 18 cm
- Dissecting forceps toothed 1x2 - 14 cm
- Operating scissors sharp/blunt - straight - 15 cm 2 pcs.
- Operating scissors sharp/blunt - curved - 15 cm 2 pcs.
- Rampléy sponge holding forceps - str - 24 cm 2 pcs.
- Museux Vulsellum forceps 8 mm - str. - 24 cm
- Cusco vaginal specula - small
- Cusco vaginal specula - medium
- Cusco vaginal specula - large
- Sims vaginal specula - small
- Sims vaginal specula - medium
- Sims vaginal specula - large
- Umbilical scissors USA Patent - 10.5 cm
- Instrument tray with lid 45x30x6.2 cm





Ai-849
 PROBE
 BUTTERFLY PROBE
 STRAIGHT BLADE
 POT-BELLIED BLADE
 ANATOMY FORCEPS
 SURGERY FORCEPS
 HOOK SHARP
 FORCEPS THIN END
 SCISSORS BLUNT/SHARP



Ai-850
 PROBE
 BUTTERFLY PROBE
 STRAIGHT BLADE
 POT-BELLIED BLADE
 ANATOMY FORCEPS
 SURGERY FORCEPS
 KLEMMER FORCEPS
 STITCH REMOVER
 FORCEPS THIN END
 SCISSORS BLUNT/SHARP
 MATHIEU NEEDLE HOLDER



Ai-851
 PROBE
 BUTTERFLY PROBE
 STRAIGHT BLADE
 POT-BELLIED BLADE
 ANATOMY FORCEPS
 SURGERY FORCEPS
 STITCH REMOVER
 FORCEPS THIN END
 SCISSORS BLUNT/SHARP
 MAYO-HEGAR HOLDER



Ai-852
 PROBE
 BUTTERFLY PROBE
 STRAIGHT BLADE
 POT-BELLIED BLADE
 ANATOMY FORCEPS
 SURGERY FORCEPS
 KLEMMER FORCEPS
 STITCH REMOVER
 FORCEPS THIN END
 SCISSORS BLUNT/SHARP
 MATHIEU NEEDLE HOLDER



Ai-853 Set of chrome plated Hegar Dilators
Include 14 dilators Ø 4-17 mm

Sims hystrometer - malleable -
33 cm - silver

Bosch/Sims scissors - 23 cm

Schroeder forceps - 25 cm
(Pozzi-Palmer)

Foerster forceps - 25 cm

26810 GYNAECOLOGY KIT
Includes 4 instruments marked
with □ in a nylon bag.





Manufacturers & Exporters of Veterinary Instruments

Sadaye Shehar Road. SIE Sialkot 51310 Pakistan

City: Sialkot-Punjab

Postal Code : 51310 email: azqa.instruments@gmail.com

Info@azqainstruments.com

Contact number +92 332 9598000

Whatapp/ WeChat +923087708383

www.azqainstruments.com

Alibaba <https://azqa.trustpass.alibaba.com/>